

**MODEL: WMLS-302F**  
**17ft. Ladderstand**

- Always Wear a Safety Harness with this Product
- Practice Using at Ground Level
- Weight Limit: 300 lbs.
- Tree Size: 9"-18" diameter

*Remington*®

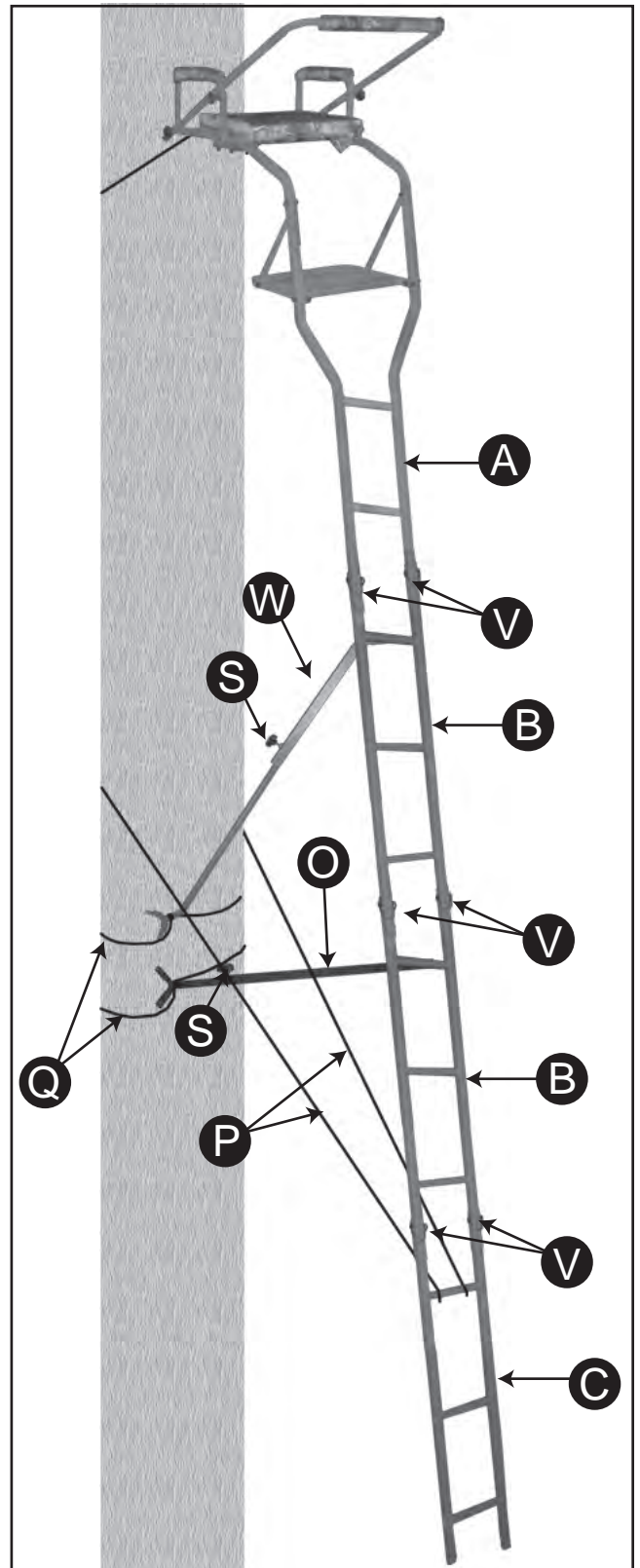
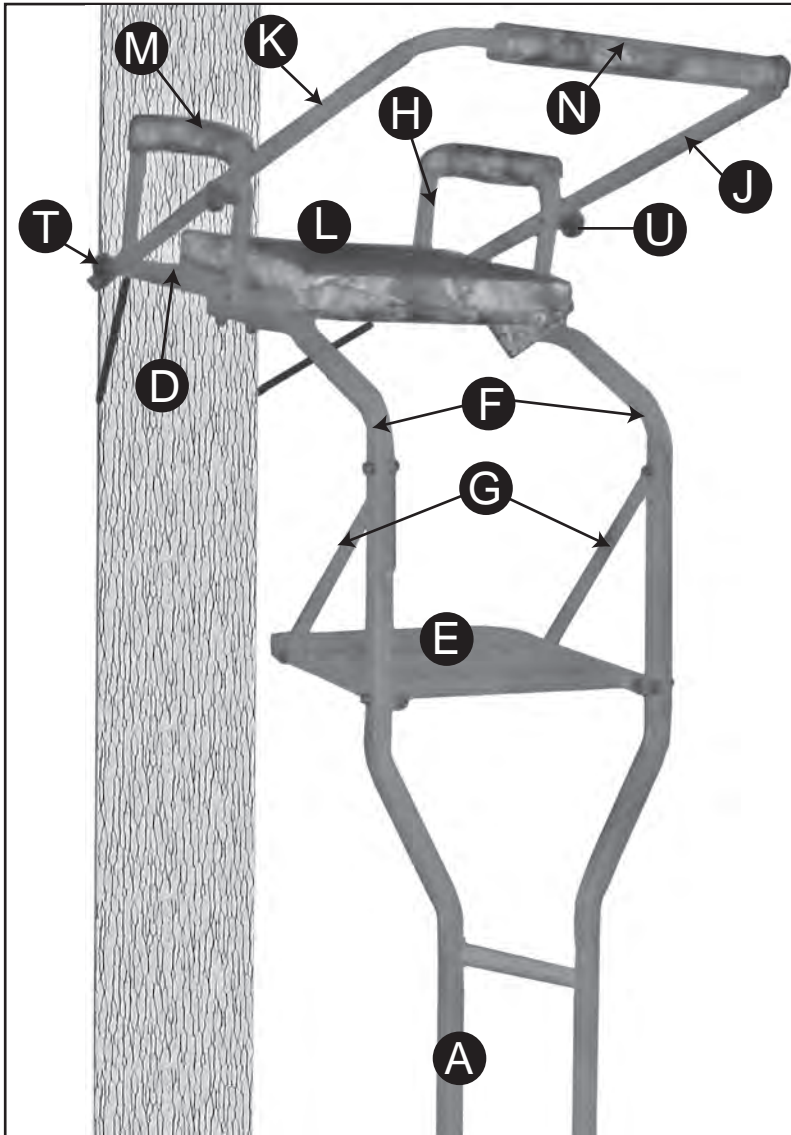

**THANK YOU!** for purchasing Remington's 17ft Ladderstand by Tahsin Industrial Corp USA.

**⚠ Warning**

**Every year serious injury and even death occurs from hunting related falls.** To ensure your safety, please **COMPLETELY** read and follow this safety manual and ALL warning labels **BEFORE** assembling, installing or utilizing this product.

DO NOT USE THIS PRODUCT BEFORE FULLY UNDERSTANDING ALL SAFETY WARNINGS AND INSTRUCTIONS. IF YOU HAVE QUESTIONS, ARE UNSURE ABOUT ANY INFORMATION OR NEED ADDITIONAL INFORMATION CONCERNING YOUR PRODUCT, CONTACT OUR CUSTOMER SERVICE DEPARTMENT AT 1-866-972-6168 OR VISIT [WWW.TREESTANDCUSTOMERSERVICE.COM](http://WWW.TREESTANDCUSTOMERSERVICE.COM) KEEP AND MAINTAIN THIS SAFETY AND INSTRUCTION MANUAL IN A SAFE LOCATION FOR FUTURE REFERENCE.

## TREESTAND SAFETY WARNINGS

Please read the following instruction manual and warnings labels completely before utilizing this tree stand. Failure to understand and execute the instructions and warnings may result in serious injury or death. In the event of an accident, have a plan for rescue, including the use of devices that may be easily reached while suspended. **NEVER** hunt without a rescue plan.

**ALWAYS** read all warnings and instructions before each use of this tree stand. Failure to read all warnings and instructions may result in serious injury or death.

**ALWAYS** wear a Full Body Safety Harness after leaving the ground. Failure to wear your Fall Arrest System (Harness) may result in serious injury or death.

**ALWAYS** use a Full Body Safety Harness when using this tree stand. This tree stand includes a TMA Certified Full Body Harness. The TMA Certified Full Body Harness must always be connected to yourself and the tree during ascending, hunting and descending. Single safety belts and chest harnesses are no longer allowed and should **NEVER** be used. If you are not wearing a full body harness properly attached to the tree that is protecting you from a fall, **DO NOT** leave the ground. Falls can occur at anytime after leaving the ground.

**ALWAYS** inspect the tree stand and the **Fall Arrest System** (Harness) for signs of wear or damage **BEFORE** each use. Also inspect to ensure that nuts and bolts are secure. Pay special attention to the harness and straps, guaranteeing that nothing has been frayed or severed. Destroy all products that cannot be repaired by the manufacturer. Contact a Customer Service Representative for replacement parts. The Fall Arrest System **MUST** be discarded and replaced after a fall has occurred.

**DO NOT** use tree stand if any nuts or bolts or parts are loose, bent, or crooked.

**NEVER** exceed total weight limit of **300 lbs.** **DO NOT** use if your combined weight with all of your hunting gear and any accessories exceeds **300 lbs.** Use of tree stand over the weight limit may result in serious injury or death.

**NEVER** let children play with or use this tree stand without adult supervision. This tree stand is not a toy.

**DO NOT** use this tree stand while under the influence of alcohol, medication or any illegal substances. Use of tree stand while under the influence of any of these substances may result in serious injury or death.

**NEVER** use this tree stand during inclement weather. **DO NOT** use tree stand during thunderstorms, snowstorms, hurricanes, tornadoes or any other weather conditions that include (but not limited to) lightning, icy conditions, or high winds that could create slippery or dangerous situations. End your hunt and return to the ground if inclement weather conditions arise.

**NEVER** use this tree stand if you have a history of health problems such as (but not limited to) heart problems, back problems, high blood pressure, impaired vision, equilibrium impairments, are afraid of heights, have been advised by a doctor or physician not to climb. If you are not physically fit, well rested, and alert, or if you have any other physical or mental condition that would impair your ability to properly use this tree stand.

**NEVER** use tree stand if you are feeling ill, nauseous, dizzy or if you have prior medical conditions that could cause a problem i.e., heart condition, joints that lock-up, spinal fusions, etc. or if you are not well rested and alert. Physical ailments can reduce your ability to safely install, utilize, and remove your tree stand. Please consult a physician prior to use.

**NEVER** wear jewelry or loose fitting clothing, which can cause hazardous conditions. Clothing may be caught in your equipment and cause you to fall. You must always wear non-slip or rubber boots. Shoelaces must be tucked into your boots. Rings and necklaces **MUST NOT** be worn.

**NEVER** use this tree stand on a tree that is dead, leaning, diseased, loose barked or on a utility pole as the tree may fall, break, or uproot and may result in serious injury or death.

**NEVER** transport any of your equipment with yourself while ascending or descending the tree. You will need to have two hands free during ascending and descending for safety. Use a haul line to pull up your firearm (unloaded, chamber opened with safety lock engaged, barrel facing towards the ground), bows, arrows, knives or any other equipment to your tree stand once you have reached your desired hunting height. **ONLY** pull up hunting equipment after the tree stand has been secured to the tree and after you and your harness have been secured to the tree. Prior to descending, lower your equipment on the opposite side of the tree from which you are climbing. Make sure that the unloaded firearm's safety lock is engaged and the gun barrel is pointing towards the ground.

**ALWAYS** hunt with a plan and a buddy. Before you leave home, let others know your exact location, when you plan to return and who is with you.

**ALWAYS** inform someone of the hunting location, where the treestand is located and the expected duration of the hunt.

**ALWAYS** attach your Full Body Harness in the manner and method described by the manufacturer. Beware of hazards associated with Full Body Harnesses and the fact that prolonged suspension in a harness may be fatal. Have in place a plan for rescue, including the use of cell phones, or signal devices that may be easily reached while suspended. If rescue personnel cannot be notified, you must have a plan for recover/escape. If you have to hang suspended for a period of time before help arrives, exercise your legs by pushing against the tree or doing any other form of continuous motion. Failure to recover in a timely manner could result in serious injury or death. If you do not have the ability to recover/escape, hunt from the ground.

**ALWAYS** carry emergency signal devices such as a cell phone, walkie-talkie, whistle, signal flare, PLD (personal location device) and flashlight with you at all times and within reach even while you are suspended in your harness. Watch for changing weather conditions. In the event of an accident, remain calm and seek help immediately.

**NEVER** modify or alter your tree stand in anyway by making repairs, replacing parts, or altering, adding or attaching anything to it except if explicitly authorized by the manufacturer. Improper installation or adjustment may cause serious injury or death. Remove all contents from box. Inspect for any damaged or missing parts. If any parts are missing or damaged, you must only use certified replacement parts. Using any other replacement parts will void product warranty. **THERE ARE NO EXTRA PARTS.** All parts **MUST** be used to ensure the safety of you and your stand. If you think parts are missing or damaged, **STOP IMMEDIATELY** and contact our Customer Service Department. Using the tree stand with missing or damaged parts may result in serious injury or death. Contact a Customer Service Representative if you have any missing, damaged or extra parts.

## TREESTAND SAFETY WARNINGS

**PRACTICE** installing, adjusting and using your tree stand at ground level prior to using it at an elevated position.

**ALWAYS** step firmly on the first rung of the bottom ladder section to set the ladder into the ground before proceeding to climb the ladder.

**NEVER** use homemade or permanently elevated stands or make modifications to a purchased tree stand.

**ALWAYS** have a minimum of three people present when installing or removing this tree stand.

**ALWAYS** know your physical limitations. Don't take chances. If you start thinking about how high you are, don't go any higher. Instead, choose a minimum height that will allow for safe, effective and comfortable hunting.

**NEVER** use this tree stand for any use other than hunting. Our tree stands are designed for hunters to wear a Full Body Harness. If you are not completely comfortable and confident with your ability to safely install, ascend, hunt and descend using this treestand and a Full Body Safety Harness, **DO NOT PROCEED.**

**ALWAYS** lean **forward towards the tree** as you climb and attach your harness to the tree before securing the platform to the tree and stepping onto the platform.

**NEVER** lean out from the tree stand for any reason.

**NEVER** use this treestand for trimming trees.

**NEVER** rely on a branch for support.

**NEVER** jump or bounce on the tree stand's platforms or ladder sections to seat it to the tree.

**NEVER** fall asleep in your tree stand as you may fall out resulting in serious injury or death.

**NEVER** adjust your tree stand while in use. **ALWAYS** ensure that you and your tree stand are safely secured to a healthy tree. Your tree stand **MUST** be attached tightly to the tree and secured in place. If the stand is not secure, it may shift while in use, resulting in serious injury or death.

**ALWAYS** maintain three points of contact when climbing the tree stand. (Two feet, one hand **or** one foot, two hands)

Instructions should be kept in a safe place and reviewed before each use. It is the responsibility of the treestand owner to furnish the complete instructions to anyone who borrows or purchases the tree stand from you.

**ALWAYS** be sure to retighten all bolts **BEFORE** each new use of tree stand.

**DO NOT** leave your tree stand outside. It must be stored inside when not in use.

The Installation Cross Straps and Stabilizer Bar **MUST** be properly installed before each use of treestand.

**ALWAYS** inspect every ladder section connection every time you use the tree stand before leaving the ground. If the ladder sections are separating, with the help of three other people remove the tree stand from the tree and reinstall.

**ALWAYS** check the ground under the tree stand to make sure it is firm and level. Sloping ground or uneven surfaces (one side of a rock or root) can cause your tree stand to tilt or shift off the tree.

**ALWAYS** read and understand all warnings and instructions before each use of tree stand. Failure to read and understand all warnings and instructions may result in serious injury or death.

**NEVER** use this tree stand with a second person. The product is designed for use by **ONE** person **ONLY.**

Read and understand manufacturer's warnings, expiration date (if applicable) and instructions on how to properly adjust the harness.

**PRACTICE** using the Full Body Safety Harness at ground level in the presence of a responsible adult to experience the feeling of hanging suspended before using in a hunting environment.

There is time to make a correct decision on what action to take if a fall occurs while wearing a Full Body Harness. It is important to remember do not panic. Remain calm and implement your practiced rescue, relief and recovery plan.

## WARNING

**DO NOT** use this ladderstand without reading and following all warnings and instructions before each use. Failure to do so may result in serious injury or death.

**ALWAYS** inspect your ladderstand before each use. **DO NOT** use if parts are missing, worn, or damaged.

**ALWAYS** wear a Full Body Harness while using this ladderstand. Failure to wear a full body harness while using this ladderstand may result in serious injury or death.

**DO NOT** exceed the ladderstand's 300 lbs. weight which includes your body weight as well as the weight of your clothes and gear. Exceeding the ladderstand's weight limit may cause the treestand to break or fail resulting in serious injury or death.

**NEVER** stand on treestand seat or arms. Lifting or pulling on these parts may cause the treestand to break or fail resulting in serious injury or death.

**NEVER** alter, modify, or damage the ladderstand. **NEVER** use if parts are missing, worn, or damaged.

**NEVER** use treestand if you are ill, tired, or have a medical condition that is aggravated by heights, dizziness, or other health care provider not to climb, or have any condition that would impair your ability to climb up or down or use treestand as it could result in serious injury or death.

**NEVER** use treestand during inclement weather. **DO NOT** use treestand during thunderstorms or any other weather conditions including (but not limited to) lightning, freezing rain, high wind that could create slippery or dangerous conditions.

**DO NOT** use ladderstand under the influence of alcohol, drugs, or medication. Using ladderstand under the influence of alcohol, drugs, or medication may result in serious injury or death.

**NEVER** use ladderstand if you have dizzy spells, a heart problem, are afraid of heights, have been advised by a doctor or other health care provider not to climb, or have any condition that would impair your ability to climb up or down or use treestand as it could result in serious injury or death.

**NEVER** remove or deface ladderstand warning labels. Replacement labels can be obtained from the address below.

**NEVER** remove any safety warning stickers from this product.

**Safety must be your first priority during the use of this product.**

# MODEL: WMLS-302F 17ft. Ladderstand

- Always Wear a Safety Harness with this Product
- Practice Using at Ground Level
- Weight Limit: 300 lbs.
- Tree Size: 9"-18" diameter

## Parts List

<b>A</b>	1 Top Ladder Section	Part # WFL-3002
<b>B</b>	2 Middle Ladder Section	Part # WFL-3022
<b>C</b>	1 Bottom Ladder Section	Part # WFL-3503
<b>D</b>	1 Seat Platform	Part # WSP-300
<b>E</b>	1 Foot Platform	Part # WFP-300
<b>F</b>	2 Handle Rail	Part # WHR-300
<b>G</b>	2 Platform Support	Part # WPS-300
<b>H</b>	2 Arm Rest	Part # WAR-301
<b>J</b>	1 Shooting Rail (Male)	Part # WSR-300
<b>K</b>	1 Shooting Rail (Female)	Part # WSR-350
<b>L</b>	1 Seat Cushion	Part # WSC-301
<b>M</b>	2 Arm Rest Cover	Part # WPAC-300
<b>N</b>	1 Shooting Rail Cover	Part # WPSC-300
<b>O</b>	1 Lower Stabilizer Bar	Part # WSB-200
<b>P</b>	2 Installation Strap	Part # IS-1000
<b>Q</b>	2 Tiedown Rope	Part # TR-1000
<b>R</b>	1 Ratchet Strap	Part # WRA-200
<b>S</b>	2 Adjustment Knob	Part # AK-100
<b>T</b>	2 Shooting Rail Knob	Part # SRK-301
<b>U</b>	2 Short Knob	Part # SK-301
<b>V</b>	6 Sleeve	Part # WS-100
<b>W</b>	1 Upper Stabilizer Bar	Part # WSB-550

## Hardware

<b>(60)</b>	6 M12x60mm Bolt	Part # 1260
<b>(40)</b>	4 M12x40mm Bolt	Part # 1240
<b>(50)</b>	2 M10x50mm Bolt	Part # 1050
<b>(45w)</b>	2 M12x45mm w/wingnut	Part # 1245W
	1 Harness	Part # 2001
	6 M10 Quickclips	Part # 1615

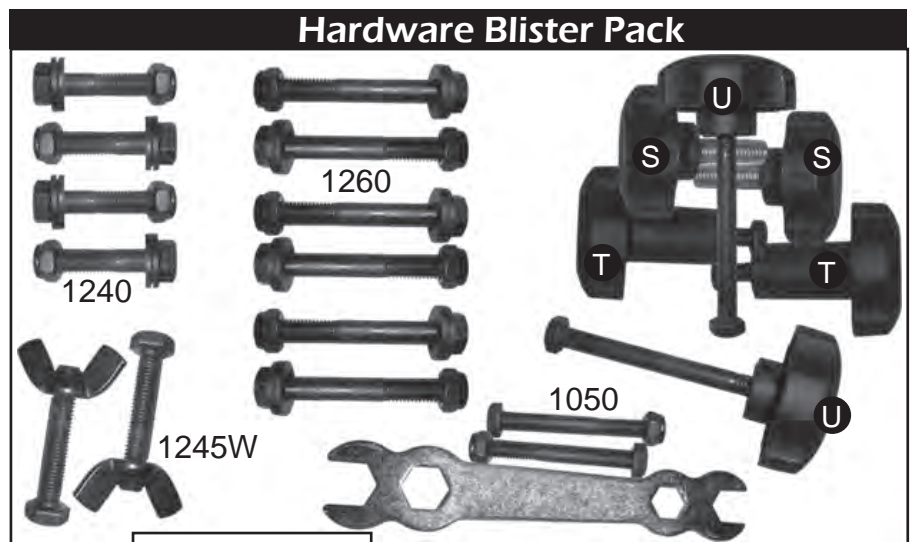
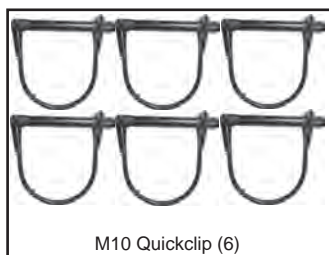
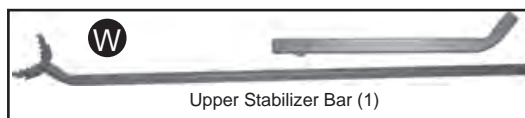
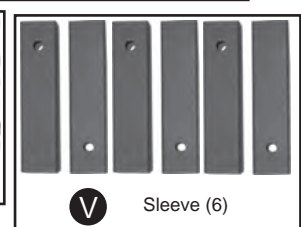
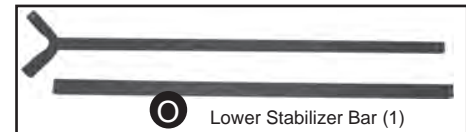
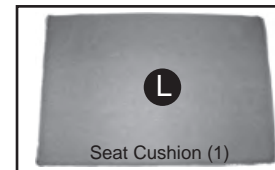
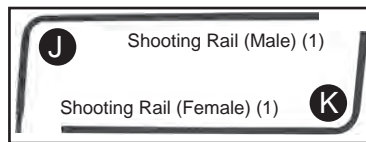
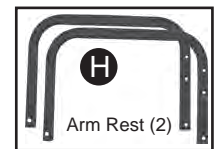
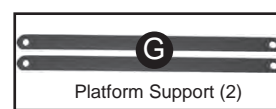
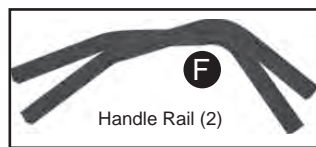
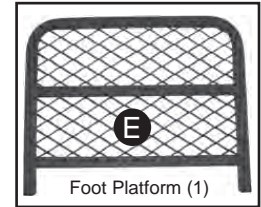
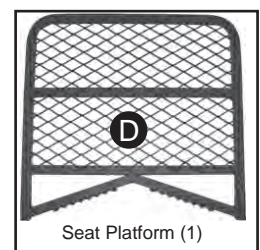

Hardware is laid out as found in blister pack

## You Will Need

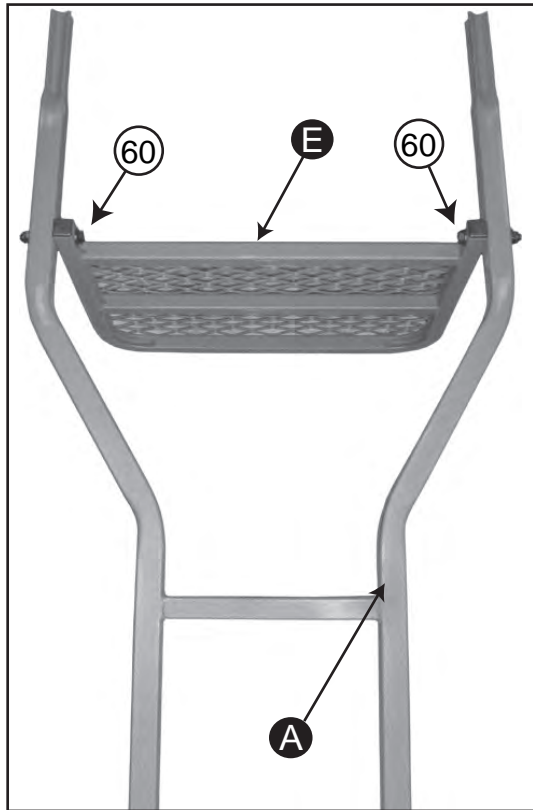
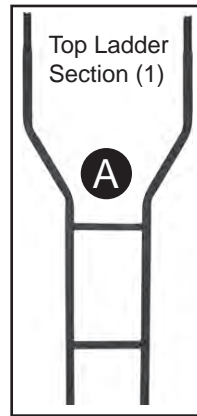
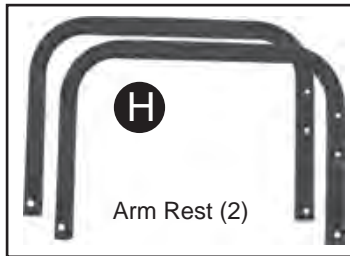
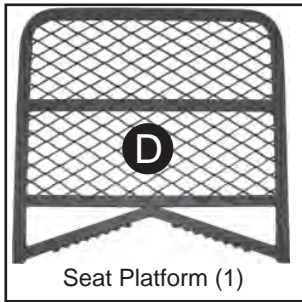

1. Attach Foot Platform **E** to the Top Ladder Section **A** using **1 - M12x60mm bolt** on each side.

2. Attach Arm Rest Cover **M** to each Arm Rest **H**. Attach the front of Arm Rest **H** to Seat Platform **D** using **1 - M10x50mm bolt** on each side.

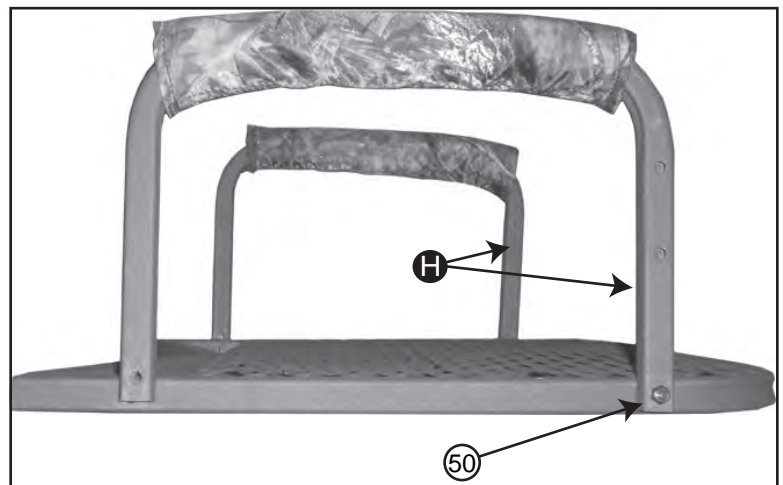

## You Will Need

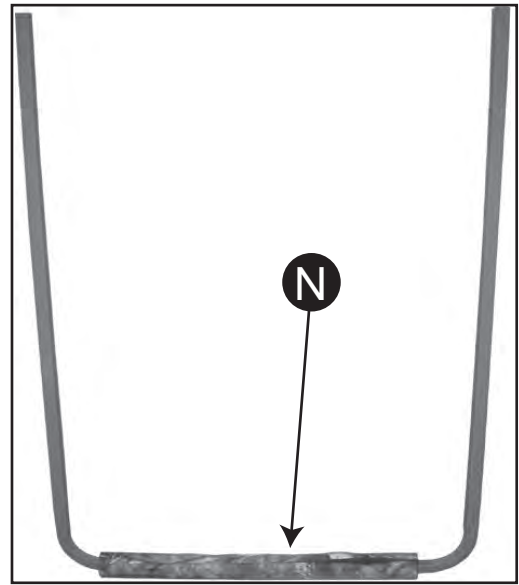
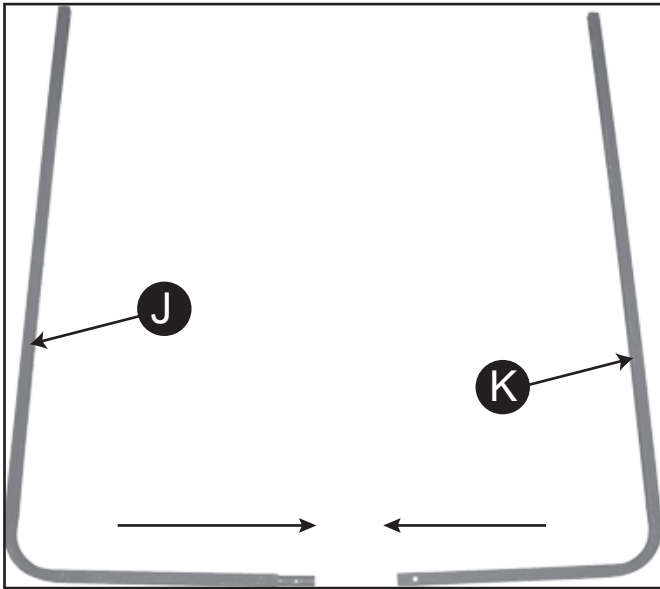
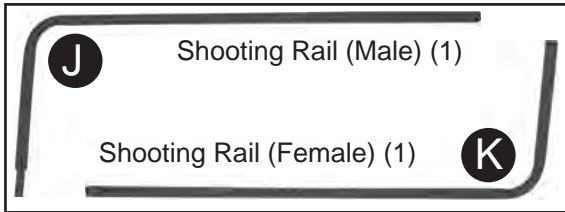

3. Slide both sections of the Shooting Rail together. Attach Shooting Rail Cover **N** to the Shooting Rail.

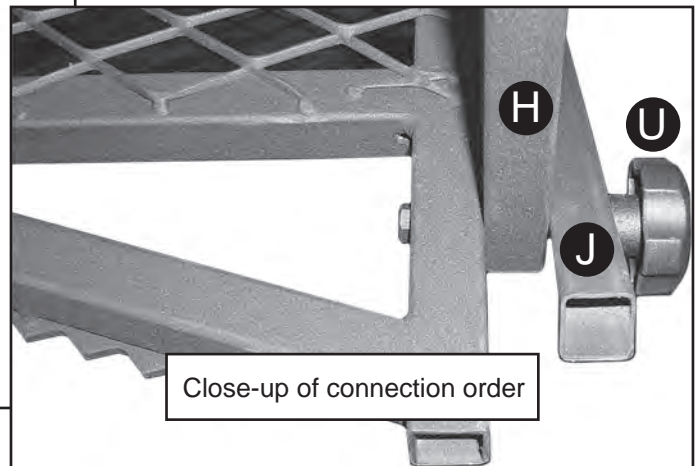
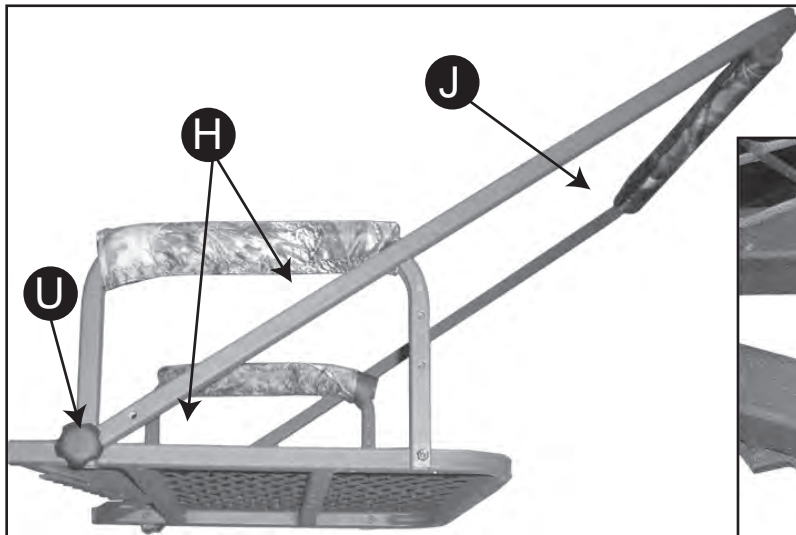

4. Attach the rear of Shooting Rail **J** to the rear of the Arm Rest **H** using Short Knob **U**. Insert the bolt through the seat platform, then through the Arm Rest and then through the Shooting Rail. Tighten the knob to secure the three parts together. Repeat for other side.

## You Will Need



Shooting Rail Knob (2)



Handle Rail (2)



M12x60mm Bolts (4)

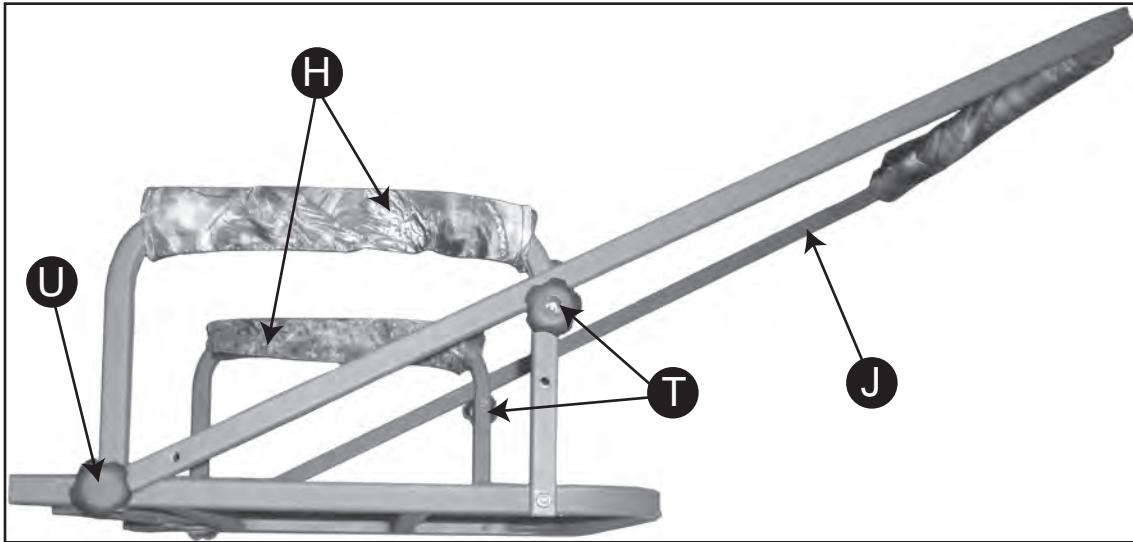

5. Insert the bolt of Shooting Rail Knob **U** through the front hole on Arm Rest **H** and secure with the plastic knob. The Shooting Rail will rest on top of the knob.

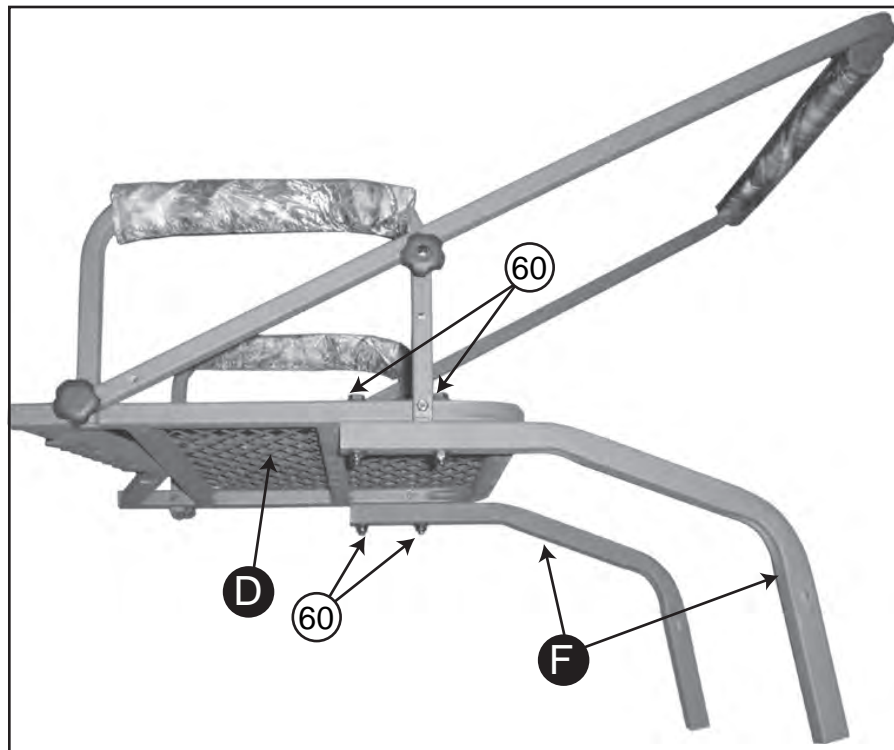

6. Attach Handle Rail **F** to the bottom of Seat Platform **D** using 2 - *M12x60mm bolts* on each side.

## You Will Need

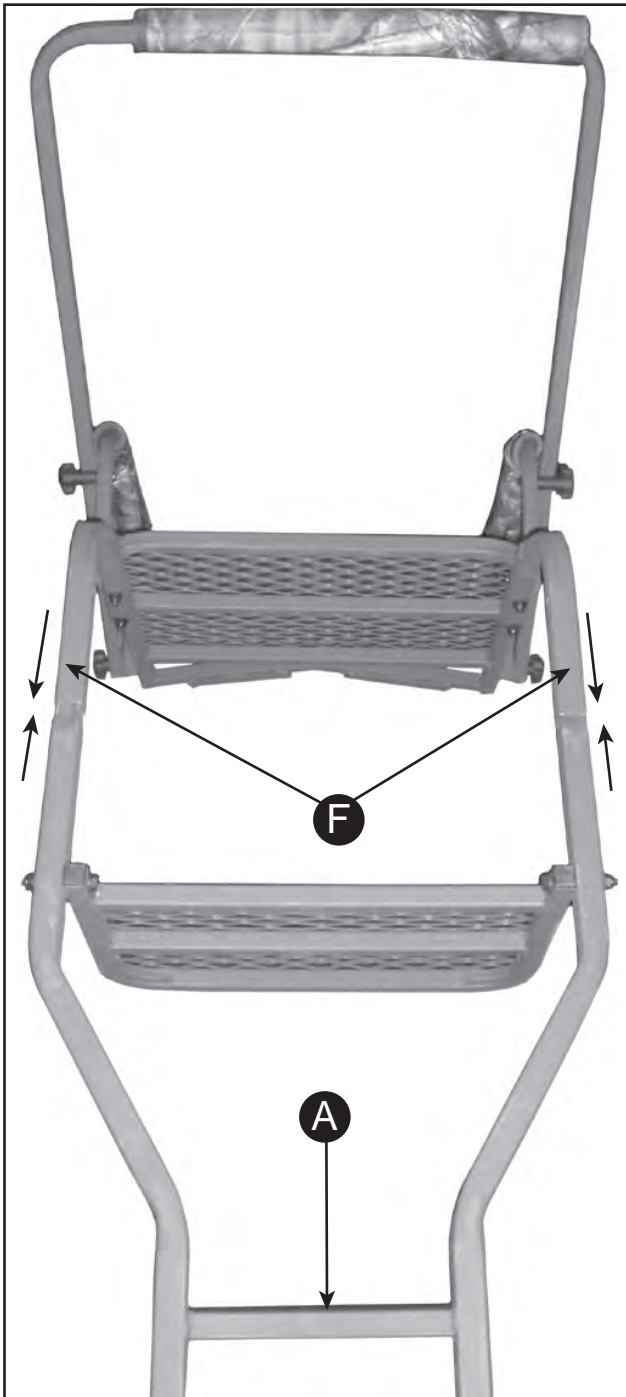

7. Slide the Top Ladder Section **A** into Handle Rails **F**.

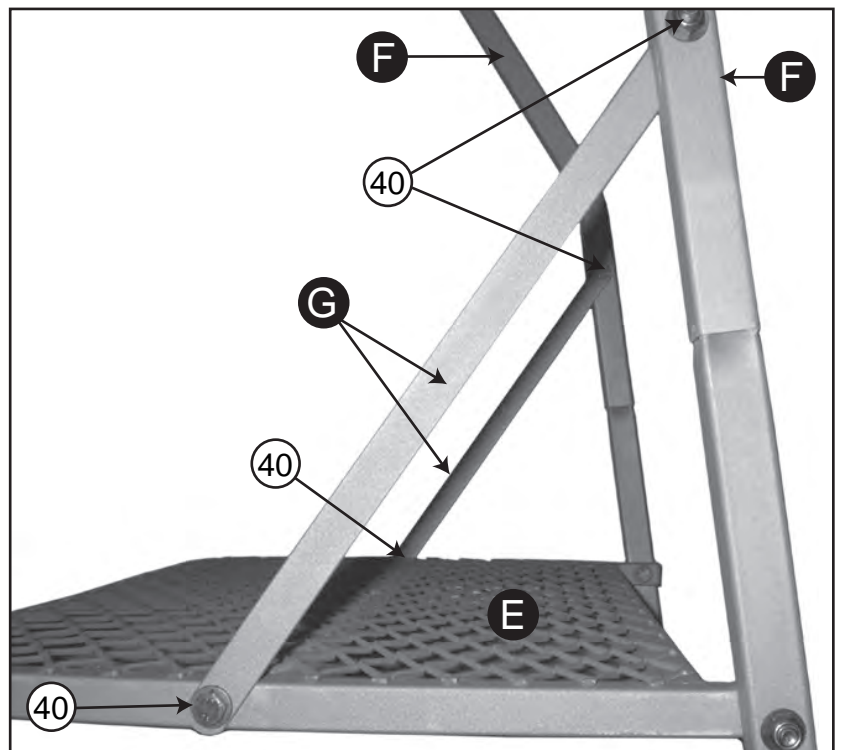

8. Attach one end of the Platform Support **G** to Foot Platform **E** using 1 - M12x40mm bolt for each side. Attach the other end of Platform Support **G** to the inside of Handle Rail **F** using 1 - M12x40mm bolt on each side.

## You Will Need

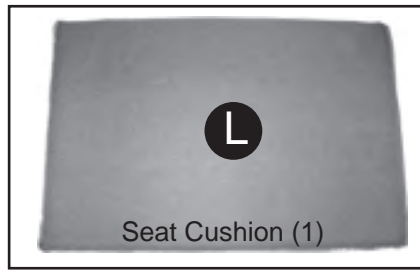

9. Attach Seat Cushion **L** to Seat Platform **D** by placing the cushion on top of the seat platform with the camo flap at the front of the platform.

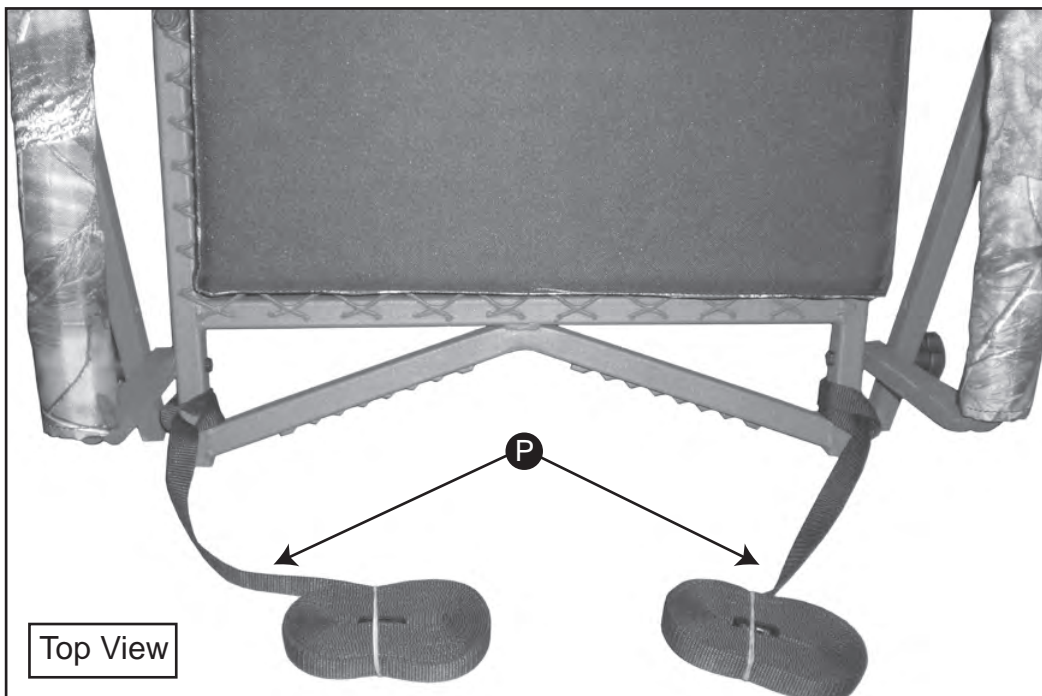

10. Attach Installation Cross Straps **P** to the rear of Seat Platform **D**. (See Installation Strap Instructions Page 1)

# Ladder Assembly Instructions

MODEL: WMLS-302F  
17ft. Ladderstand

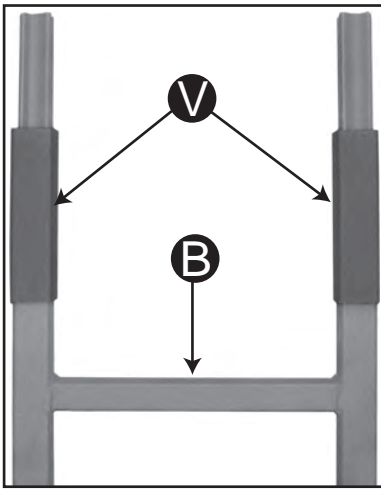

1. Slide Sleeves **V** over the crimps of Middle Ladder Section **B**.

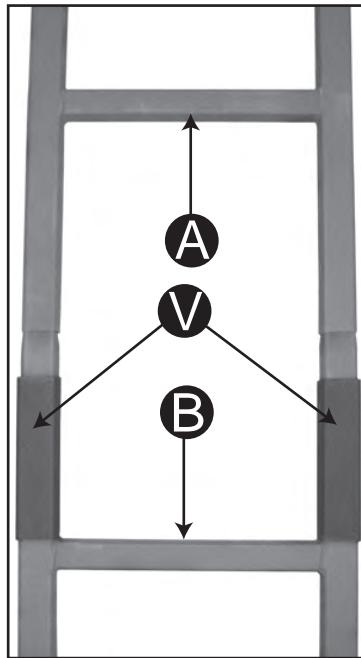

2. Insert Middle Ladder Section **B** into the Top Ladder Section **A**.



3. Slide the Sleeves over the joint where ladder sections are connected.

## NOTE

The Brackets on the Middle Ladder Sections **MUST** be facing towards the tree.

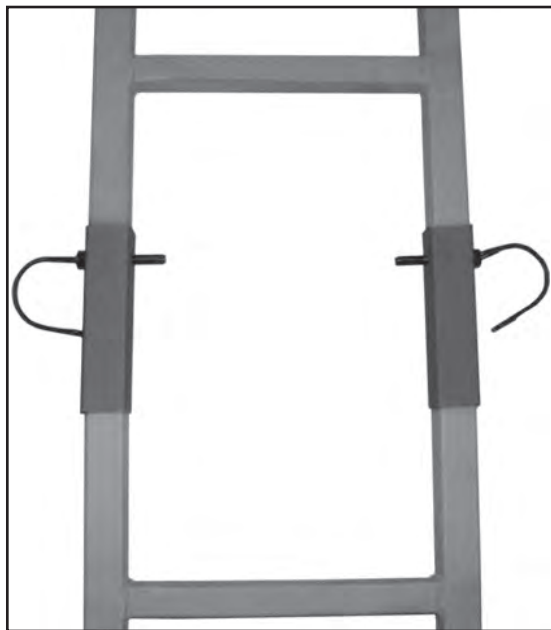

4. Insert 1 - **Quickclip** through the hole on the sleeve, and through the ladder sections on each side of the ladder.

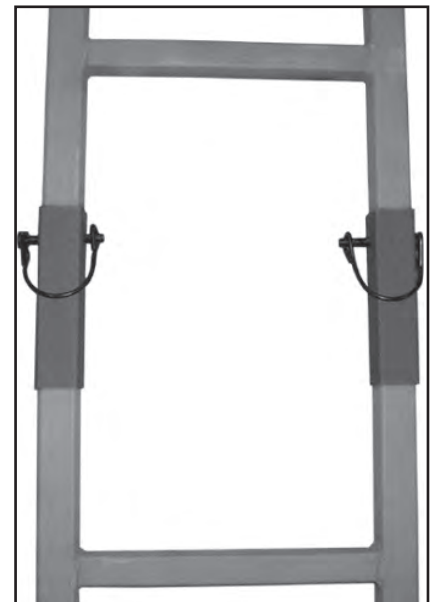

5. Close the quickclip to secure the ladder sections together.

6. Follow these above steps to attach each remaining ladder section to each other.



1.

1. Make sure Installation Straps **P** are secured on each side of the platform by following **Installation Strap Instructions Page 1**.

Remove the rubber band from around the straps. Let the straps hang loose.

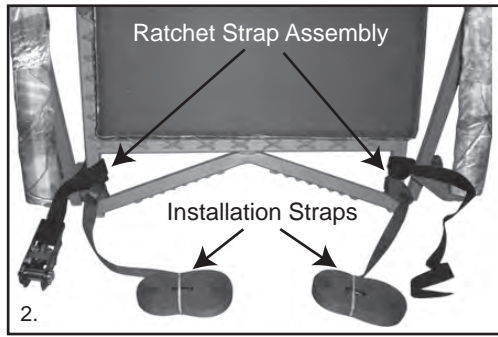

2.

2. Attach Ratchet **R** to the outermost corners of the Handle Rail just behind the Installation Straps. (Follow the first three steps of the Installation Strap Instructions.)

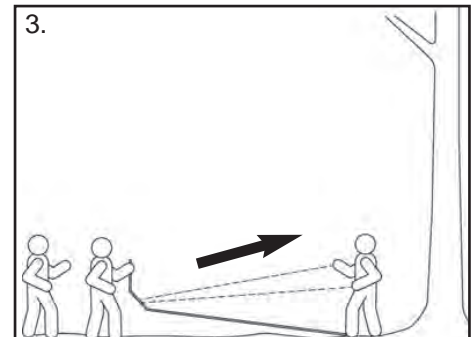

3.

3. Position bottom of stand 4-5 feet from base of tree.

**NOTE:** Drawings are for illustration purposes only and may not depict actual product.

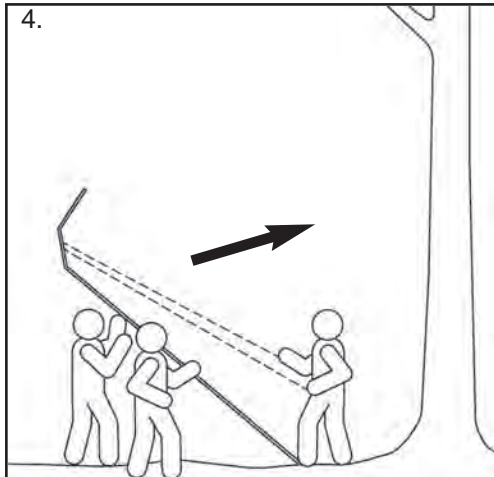

4.

4. One person will stand at the base of ladder with his/her foot on bottom rung while holding installation straps. This will prevent tree stand from sliding. Two people will stand at opposite ends of tree stand, facing Platform and slowly walk tree stand upward using rungs of ladder.

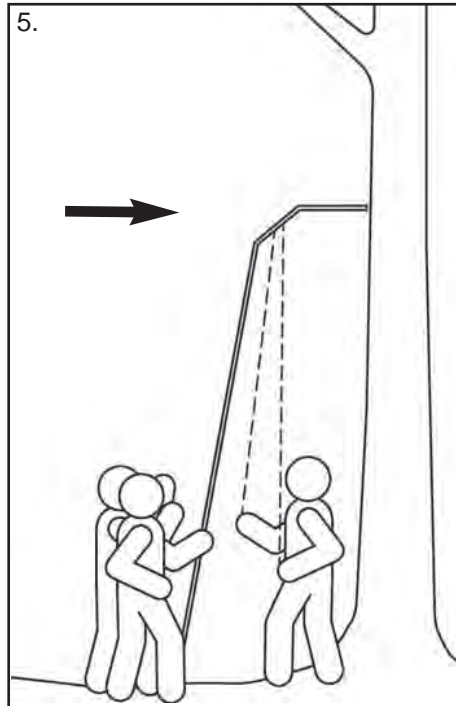

5.

5. As tree stand is being raised, the person holding Installation Straps will pull toward themselves to take up slack. It will steady and ease the weight of stand on the other two people. Continue walking stand upward, until Tree Contact is resting against the tree.

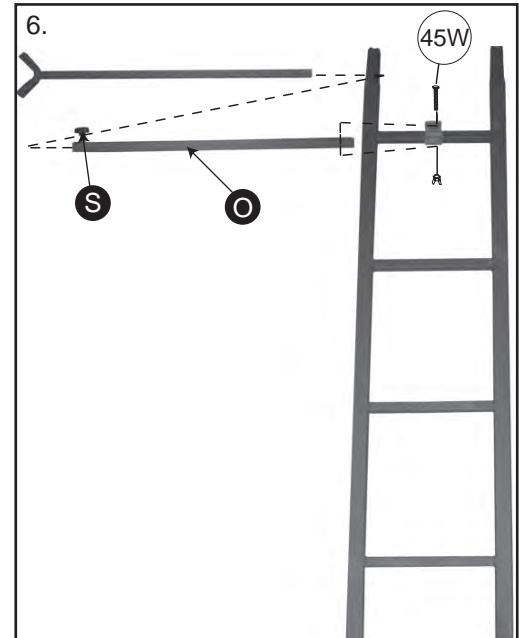

6.

6. Slide the inner part of Lower Stabilizer Bar into the outer part. Attach Lower Stabilizer Bar **O** to the bracket attached to the top rung of the Middle Ladder Section with **1 - 45W bolt and 1 wingnut**.

Insert the Adjustment Knob **S** in the Stabilizer bar at the proper adjustment point to the tree.

**WARNING** Installation Straps and Stabilizer Bar **MUST** be installed and secured prior to climbing the tree stand.

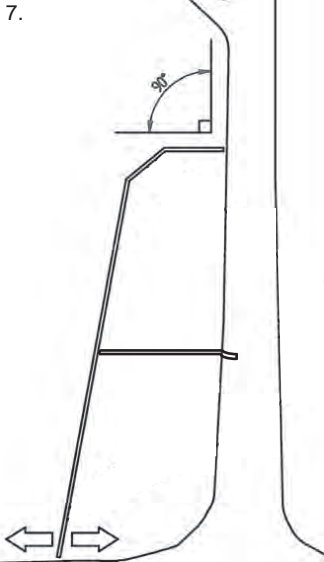

7. Move base of ladder toward or away from tree slightly in order to make Platform as parallel to the ground as possible. Apply your full weight to the first step so it settles into the ground.

8. Tie one end of Tiedown Rope **Q** to the inner part of Lower Stabilizer Bar near the flanged end. Wrap the rope around the back of the tree once. Then tie the other end of the rope to the stabilizer bar.

**⚠ WARNING**  
Installation Straps and both Stabilizer Bars **MUST** be secured prior to climbing the tree stand to the platform.

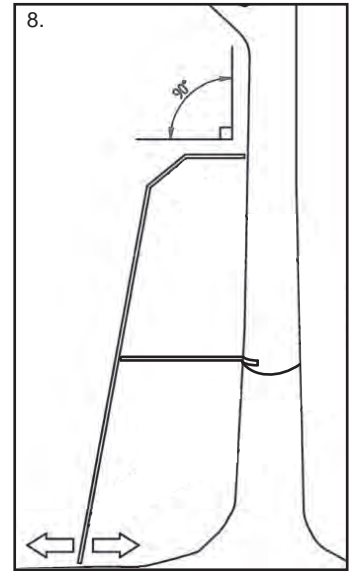

9. Cross Installation Straps behind tree. Attach to the bottom ladder section by following **Installation Strap Instructions Steps 4-8**.

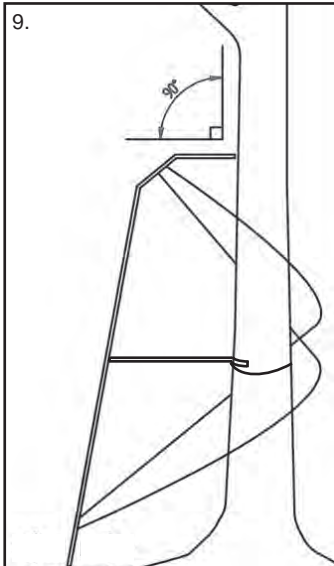

10. After the ladder stand has been secured to the tree with the installation straps, and the lower stabilizer bar has been securely attached to the tree, continue to have two people hold the ladder, climb cautiously up the ladder to install the outer part of the upper stabilizer bar.

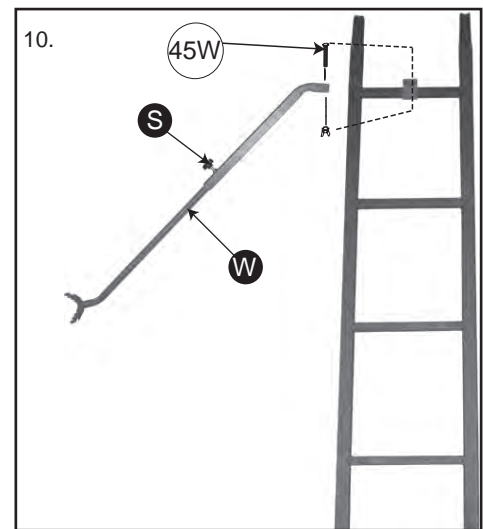

11. Attach the outer part of Upper Stabilizer Bar **W** to the bracket attached to the top rung of the upper Middle Ladder Section with **1 - 12x45mm Bolt and 1 wingnut**.

Climb back down the ladder. Slide the inner part of Upper Stabilizer Bar into the outer. Insert Adjustment Knob **S** in the Stabilizer bar at the proper adjustment point to the tree and tie the rope around the flanged end.

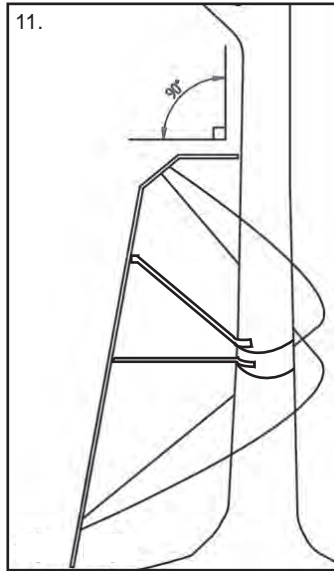

12. After the ladder stand has been secured to the tree with the installation straps, and the stabilizer bars have been securely attached to the tree, continue to have two people hold the ladder, climb cautiously up to the platform. Once you reach the top, **IMMEDIATELY ATTACH YOUR SAFETY HARNESS TO THE TREE**. Keep the tether strap above your head.



13. Wrap the strap of Ratchet around the back of the tree once and thread through the ratchet. **(See Ratchet Strap Instructions)**. Ratchet strap tight.

**⚠ WARNING**  
Provided Safety Harnesses are tested and rated to prevent falls on people **300 lbs and under**.

# Installation Strap Instructions

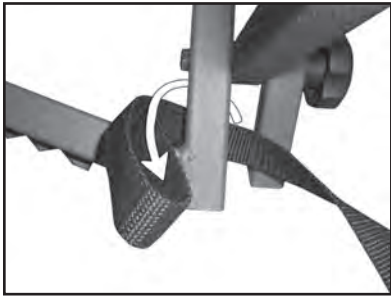

1. Place looped end of strap under platform.

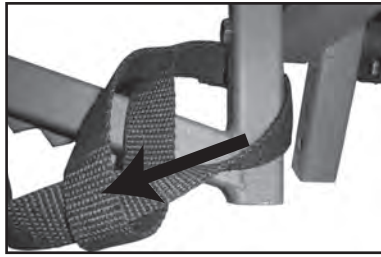

2. Insert loose end of strap through the loop.

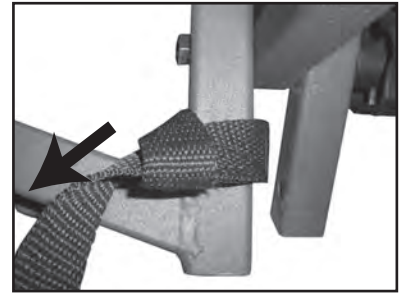

3. Pull to tighten. Continue with these steps to install the other strap on the other side of the platform.

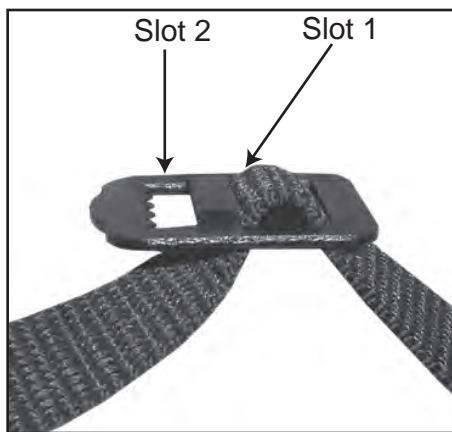

4. Place loose end of strap with clip, under the top rung of the bottom ladder section.



5. Insert the strap through Slot 1 on the clip.



6. Insert the strap through the Slot 2 with the teeth.

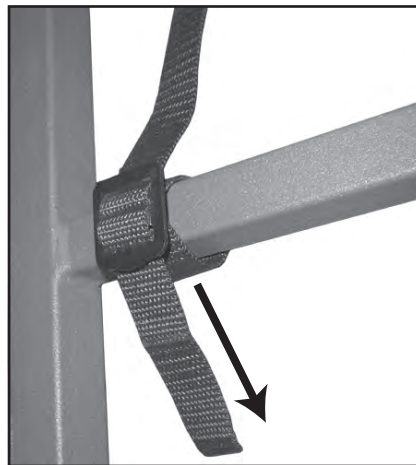

7. Pull strap to tighten.

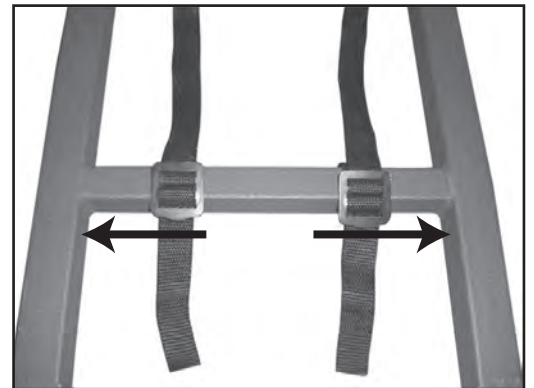

8. Slide the buckles out to the sides to create tension on the straps.

**⚠ WARNING** DO NOT sit on seat platform until the ratchet and installation straps have been secured.

# Ratchet Strap Instructions

You **MUST** follow these instructions prior to installation

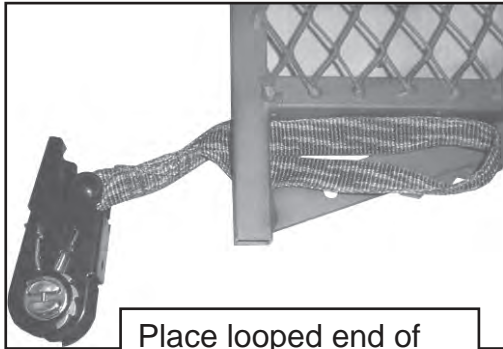

Place looped end of Ratchet under platform

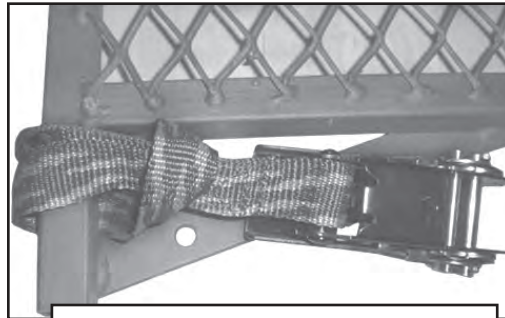

Insert ratchet through loop

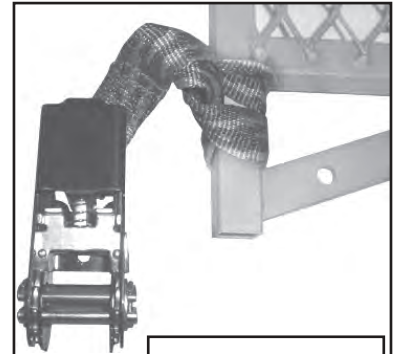

Pull to tighten

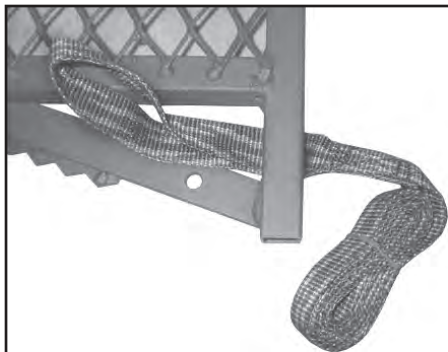

Place looped end of strap under platform

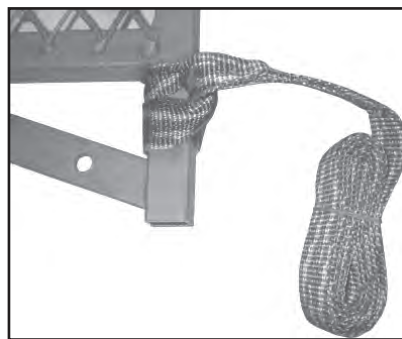

Insert strap through loop

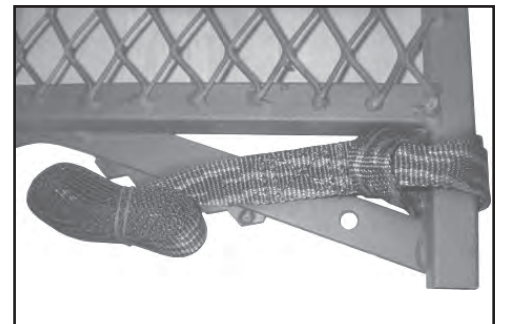

Pull to tighten

## Detailed Ratchet Strap Instructions

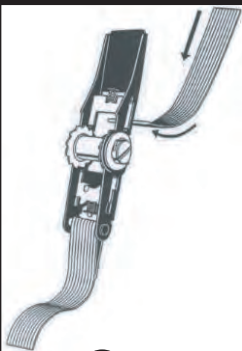

1

Open ratchet handle flat and insert end of strap through opening.

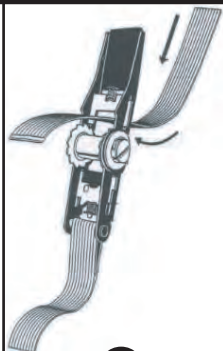

2

Pull Strap through opening

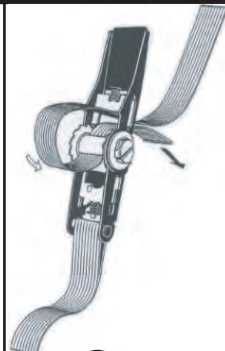

3

Insert end of strap through slot in ratchet wheel.

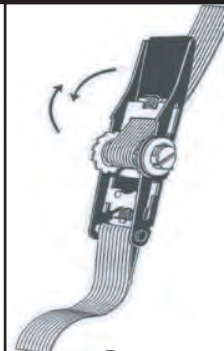

4

Ratchet handle back and forth to tighten strap

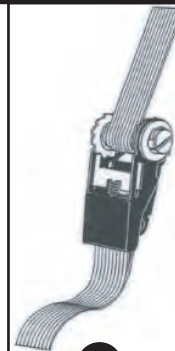

5

After strap is tight, close handle to the locked position

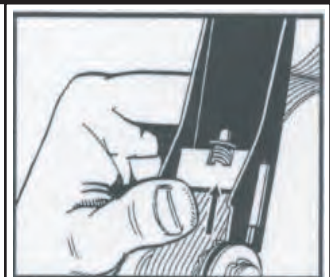

6

To release tension, push spring loaded retaining lock and simultaneously pull on strap.



# WARNING

**ALWAYS** read and understand all warnings and instructions before each use of this product. Failure to read and understand all warnings and instructions may result in serious injury or death.

**ALWAYS** inspect the tree stand for signs of wear or damage **BEFORE** each use. Also inspect to ensure that nuts and bolts are secure and straps are not frayed, worn, or broken.

**NEVER** exceed weight limit of **300 lbs. DO NOT** use if your combined weight with all your hunting gear and any accessories exceeds **300 lbs.** Use of tree stand over the weight limit may result in serious injury or death.

**ALWAYS** wear a Fall Arrest System (FAS) that meets TMA standards after leaving the ground. If you are not wearing an FAS, **DO NOT leave the ground.** Failure to wear an FAS may result in serious injury or death.

**DO NOT** use this tree stand while under the influence of alcohol, medication, or illegal substances. Use of tree stand while under the influence of any of these substances may result in serious injury or death.

**NEVER** use this tree stand if you have a history of health problems such as (*but not limited to*) heart problems, back problems, impaired vision, equilibrium impairments are afraid of heights or have been advised by a doctor not to do any strenuous activity. If you are feeling ill, nauseous, or dizzy **DO NOT** use this tree stand or If you are not physically fit, well rested and alert. Physical ailments can reduce your ability to safely install, utilize and remove your tree stand.

**NEVER** use this tree stand during inclement weather such as (but not limited to) thunderstorms, snowstorms, hurricanes, icy conditions, or high winds that could create slippery or dangerous situations.

**DO NOT** modify or alter your tree stand.

**NEVER** use this tree stand on a dead, leaning, loose barked tree or on a utility pole as the tree may fall, break, or uproot and may result in serious injury or death.

**NEVER** leave the ground without checking every ladder section connection to ensure they are firmly connected. If ladder sections are separating, with the help of at least two other people, remove the tree stand from the tree, tighten all connections and reinstall on the tree.

**NEVER** step up to the platform. Climbing aids such as stick ladders, **MUST** extend above the platform of the hang-on to allow the user to step down on the platform. The Full Body Harness **MUST always** be attached to the tree even when stepping down into the tree stand.

**NEVER** remove or deface warning labels.

Item # WMLS-302F  
WMLS-301FB