

19' WRAPAROUND LADDERSTAND

MODEL: 51039

- Always Wear a Safety Harness with this Product
- Practice Using at Ground Level
- Weight Limit: 500 lbs.
- Tree Size: 9"-18" diameter

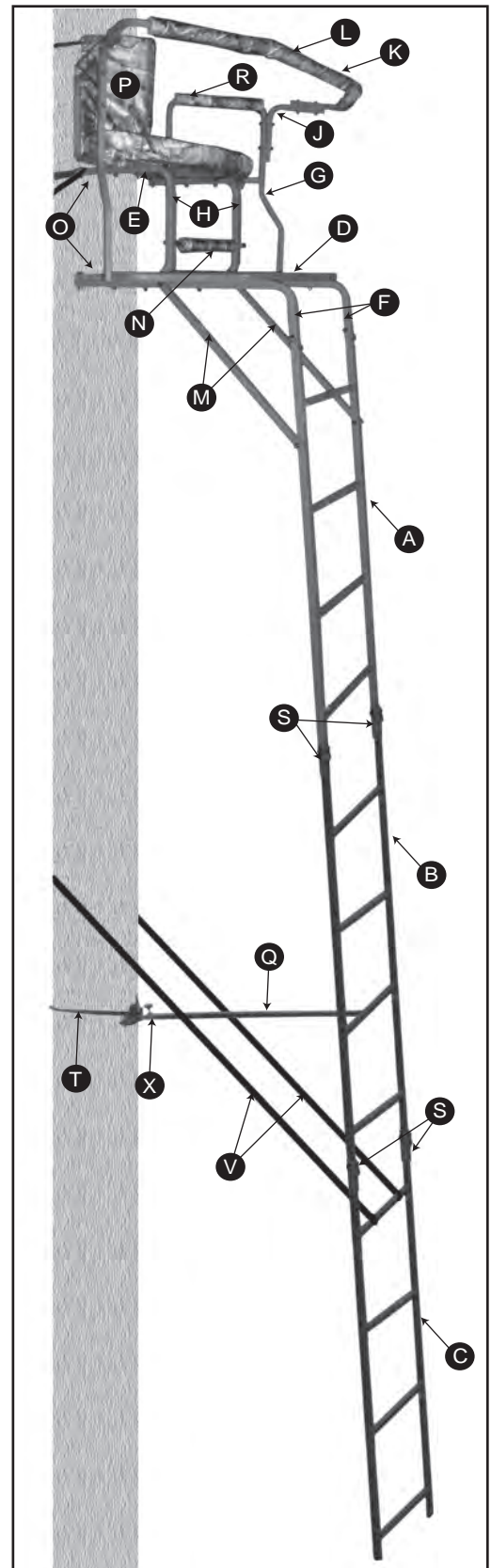
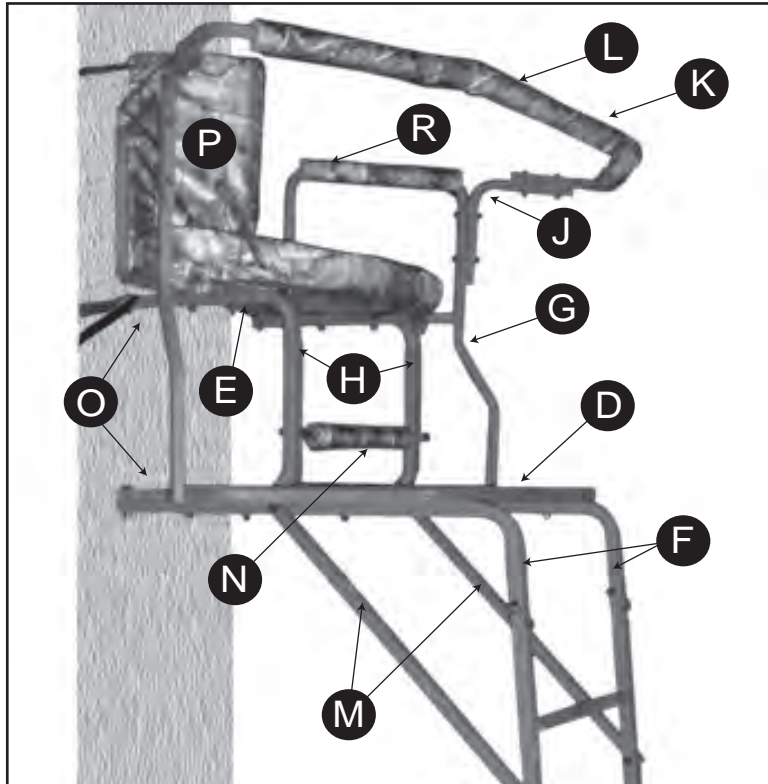

THANK YOU! for purchasing the 19' Wraparound Ladderstand by Ameristep Inc.

A Warning

Every year serious injury and even death occurs from hunting related falls. To ensure your safety, please **COMPLETELY** read and follow this safety manual and ALL warning labels **BEFORE** assembling, installing or utilizing this product.

DO NOT USE THIS PRODUCT BEFORE FULLY UNDERSTANDING ALL SAFETY WARNINGS AND INSTRUCTIONS. IF YOU HAVE QUESTIONS, ARE UNSURE ABOUT ANY INFORMATION OR NEED ADDITIONAL INFORMATION CONCERNING YOUR PRODUCT, CONTACT OUR CUSTOMER SERVICE DEPARTMENT AT 1-8866-972-6168 OR VISIT WWW.TREESTANDCUSTOMERSERVICE.COM. KEEP AND MAINTAIN THIS SAFETY AND INSTRUCTION MANUAL IN A SAFE LOCATION FOR FUTURE REFERENCE.

TREESTAND SAFETY WARNINGS

Please read the following instruction manual and warnings labels completely before utilizing this tree stand. Failure to understand and execute the instructions and warnings may result in serious injury or death. In the event of an accident, have a plan for rescue, including the use of devices that may be easily reached while suspended. **NEVER** hunt without a rescue plan.

ALWAYS read all warnings and instructions before each use of this tree stand. Failure to read all warnings and instructions may result in serious injury or death.

ALWAYS wear a Full Body Safety Harness after leaving the ground. Failure to wear your Fall Arrest System (Harness) may result in serious injury or death.

ALWAYS use a Full Body Safety Harness when using this tree stand. This tree stand includes a TMA Certified Full Body Harness. The TMA Certified Full Body Harness must always be connected to yourself and the tree during ascending, hunting and descending. Single safety belts and chest harnesses are no longer allowed and should **NEVER** be used. If you are not wearing a full body harness properly attached to the tree that is protecting you from a fall, **DO NOT** leave the ground. Falls can occur at anytime after leaving the ground.

ALWAYS inspect the tree stand and the **Fall Arrest System (Harness)** for signs of wear or damage **BEFORE** each use. Also inspect to ensure that nuts and bolts are secure. Pay special attention to the harness and straps, guaranteeing that nothing has been frayed or severed. Destroy all products that cannot be repaired by the manufacturer. Contact a Customer Service Representative for replacement parts. The Fall Arrest System **MUST** be discarded and replaced after a fall has occurred.

DO NOT use tree stand if any nuts or bolts or parts are loose, bent, or crooked.

NEVER exceed total weight limit of **500 lbs.** **DO NOT** use if the total combined weight of one person with all of your hunting gear and any accessories exceeds **300 lbs.** or the combined weight of two people and equipment exceeds **500 lbs.** **DO NOT exceed the weight limit of the safety harness, refer to harness manufacturer's warnings for weight limit of safety harness.** Use of tree stand over the weight limit may result in serious injury or death.

NEVER let children play with or use this tree stand without adult supervision. This tree stand is not a toy.

DO NOT use this tree stand while under the influence of alcohol, medication or any illegal substances. Use of tree stand while under the influence of any of these substances may result in serious injury or death.

NEVER use this tree stand during inclement weather. **DO NOT** use tree stand during thunderstorms, snowstorms, hurricanes, tornadoes or any other weather conditions that include (but not limited to) lightning, icy conditions, or high winds that could create slippery or dangerous situations. End your hunt and return to the ground if inclement weather conditions arise.

NEVER use this tree stand if you have a history of health problems such as (but not limited to) heart problems, back problems, high blood pressure, impaired vision, equilibrium impairments, are afraid of heights, have been advised by a doctor or physician not to climb. If you are not physically fit, well rested, and alert, or if you have any other physical or mental condition that would impair your ability to properly use this tree stand.

NEVER use tree stand if you are feeling ill, nauseous, dizzy or if you have prior medical conditions that could cause a problem i.e., heart condition, joints that lock-up, spinal fusions, etc. or if you are not well rested and alert. Physical ailments can reduce your ability to safely install, utilize, and remove your tree stand. Please consult a physician prior to use.

NEVER wear jewelry or loose fitting clothing, which can cause hazardous conditions. Clothing may be caught in your equipment and cause you to fall. You must always wear non-slip or rubber boots. Shoelaces must be tucked into your boots. Rings and necklaces **MUST NOT** be worn.

NEVER use this tree stand on a tree that is dead, leaning, diseased, loose barked or on a utility pole as the tree may fall, break, or uproot and may result in serious injury or death.

NEVER transport any of your equipment with yourself while ascending or descending the tree. You will need to have two hands free during ascending and descending for safety. Use a haul line to pull up your firearm (unloaded, chamber opened with safety lock engaged, barrel facing towards the ground), bows, arrows, knives or any other equipment to your tree stand once you have reached your desired hunting height. **ONLY** pull up hunting equipment after the tree stand has been secured to the tree and after you and your harness have been secured to the tree. Prior to descending, lower your equipment on the opposite side of the tree from which you are climbing. Make sure that the unloaded firearm's safety lock is engaged and the gun barrel is pointing towards the ground.

ALWAYS hunt with a plan and a buddy. Before you leave home, let others know your exact location, when you plan to return and who is with you.

ALWAYS inform someone of the hunting location, where the treestand is located and the expected duration of the hunt.

ALWAYS attach your Full Body Harness in the manner and method described by the manufacturer. Beware of hazards associated with Full Body Harnesses and the fact that prolonged suspension in a harness may be fatal. Have in place a plan for rescue, including the use of cell phones, or signal devices that may be easily reached while suspended. If rescue personnel cannot be notified, you must have a plan for recover/escape. If you have to hang suspended for a period of time before help arrives, exercise your legs by pushing against the tree or doing any other form of continuous motion. Failure to recover in a timely manner could result in serious injury or death. If you do not have the ability to recover/escape, hunt from the ground.

ALWAYS carry emergency signal devices such as a cell phone, walkie-talkie, whistle, signal flare, PLD (personal location device) and flashlight with you at all times and within reach even while you are suspended in your harness. Watch for changing weather conditions. In the event of an accident, remain calm and seek help immediately.

NEVER modify or alter your tree stand in anyway by making repairs, replacing parts, or altering, adding or attaching anything to it except if explicitly authorized by the manufacturer. Improper installation or adjustment may cause serious injury or death. Remove all contents from box. Inspect for any damaged or missing parts. If any parts are missing or damaged, you must only use certified replacement parts. Using any other replacement parts will void product warranty. **THERE ARE NO EXTRA PARTS.** All parts **MUST** be used to ensure the safety of you and your stand. If you think parts are missing or damaged, **STOP IMMEDIATELY** and contact our Customer Service Department. Using the tree stand with missing or damaged parts may result in serious injury or death. Contact a Customer Service Representative if you have any missing, damaged or extra parts.

TREESTAND SAFETY WARNINGS

PRACTICE installing, adjusting and using your tree stand at ground level prior to using it at an elevated position.

ALWAYS step firmly on the first rung of the bottom ladder section to set the ladder into the ground before proceeding to climb the ladder.

NEVER use homemade or permanently elevated stands or make modifications to a purchased tree stand.

ALWAYS have a minimum of three people present when installing or removing this tree stand.

ALWAYS know your physical limitations. Don't take chances. If you start thinking about how high you are, don't go any higher. Instead, choose a minimum height that will allow for safe, effective and comfortable hunting.

NEVER use this tree stand for any use other than hunting. Our tree stands are designed for hunters to wear a Full Body Harness. If you are not completely comfortable and confident with your ability to safely install, ascend, hunt and descend using this product and a Full Body Safety Harness, **DO NOT PROCEED**.

ALWAYS lean **forward as you climb** and attach your harness to the tree before securing the platform to the tree and stepping onto the platform.

NEVER lean out from the tree stand for any reason.

NEVER use this product for trimming trees.

NEVER rely on a branch for support.

NEVER jump or bounce on the tree stand's platforms or ladder sections to seat it to the tree.

NEVER fall asleep in your tree stand as you may fall out resulting in serious injury or death.

NEVER adjust your tree stand while in use. **ALWAYS** ensure that you and your tree stand are safely secured to a healthy tree. Your tree stand **MUST** be attached tightly to the tree and secured in place. If the stand is not secure, it may shift while in use, resulting in serious injury or death.

Instructions should be kept in a safe place and reviewed before each use. It is the responsibility of the treestand owner to furnish the complete instructions to anyone who borrows or purchases the tree stand from you.

ALWAYS be sure to retighten all bolts **BEFORE** each new use of tree stand.

DO NOT leave your tree stand outside. It must be stored inside when not in use.

ALWAYS maintain three points of contact when climbing the tree stand. (Two feet, one hand **or** one foot, two hands)

The Installation Cross Straps and Stabilizer Bar **MUST** be properly installed before each use of treestand.

ALWAYS inspect every ladder section connection every time you use the tree stand before leaving the ground. If the ladder sections are separating, with the help of three other people remove the tree stand from the tree and reinstall.

ALWAYS check the ground under the treestand to make sure it is firm and level. Sloping ground or uneven surfaces (one side of a rock or root) can cause your tree stand to tilt or shift off the tree.

ALWAYS read and understand all warnings and instructions before each use of tree stand. Failure to read and understand all warnings and instructions may result in serious injury or death.

NEVER use this tree stand with a third person. The product is designed for use by **ONE** person or **TWO** people.

Read and understand manufacturer's warnings, expiration date (if applicable) and instructions on how to properly adjust the harness.

PRACTICE using the Full Body Safety Harness at ground level in the presence of a responsible adult to experience the feeling of hanging suspended before using in a hunting environment.

There is time to make a correct decision on what action to take if a fall occurs while wearing a Full Body Harness. It is important to remember do not panic. Remain calm and implement your practiced rescue, relief and recovery plan.

! WARNING

DO NOT use this ladderstand without reading and following all warnings and instructions before each use. Failure to do so may result in serious injury or death.

ALWAYS inspect your ladderstand before each use. **DO NOT** use if parts are missing, worn, or damaged.

ALWAYS wear a Full Body Harness while using this ladderstand. Failure to wear a full body harness while using this ladderstand may result in serious injury or death.

DO NOT use ladder stand if combined weight of one person and equipment exceeds **300** lbs. **DO NOT** exceed the weight limit of the harness. Refer to harness manufacturers warnings for safety harness.

NEVER stand on treestand seat or armrests. Standing on these parts may cause the treestand to fall resulting in serious injury or death.

NEVER make any modifications to the ladderstand. Making so many modifications to the ladderstand may result in serious injury or death.

NEVER use ladderstand on a tree that is dead, diseased, leaning, or rotten. A tree that is leaning may fall, break, or uprooted may result in serious injury or death.

NEVER use ladderstand during inclement weather. **DO NOT** use treestand during thunderstorms or any other weather conditions (but not limited to) lightning, freezing rain, high wind that could create slippery or dangerous conditions.

DO NOT use ladderstand under the influence of alcohol, drugs, or medication. Using ladderstand under the influence of alcohol, drugs, or medication may result in serious injury or death.

NEVER use ladderstand if you have dizzy spells, a heart problem, are afraid of heights, have been advised by a doctor or other health care provider not to climb, or have any condition that would impair your ability to climb up or down or use treestand as it could result in serious injury or death. Please consult your physician prior to use.

NEVER remove or deface ladderstand warning labels. Replacement labels can be obtained from the address below.

SAMPLE

NEVER remove any safety warning stickers from this product.

Safety must be your first priority during the use of this product.

19' WRAPAROUND LADDERSTAND

MODEL: 51039

- Always Wear a Safety Harness with this Product
- Practice Using at Ground Level
- Weight Limit: 500 lbs.
- Tree Size: 9"-18" diameter

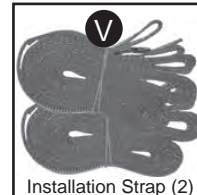
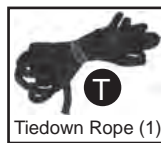
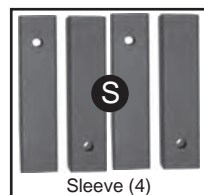
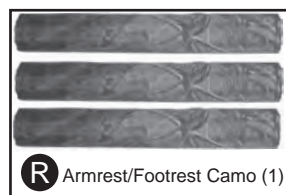
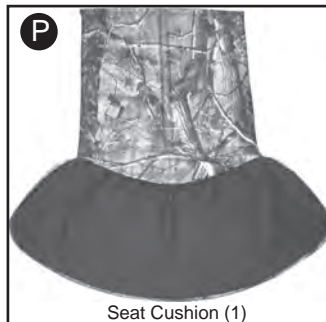
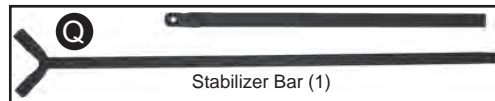
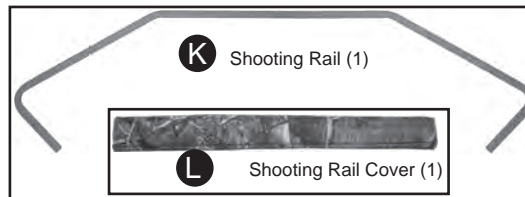
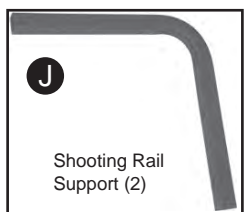
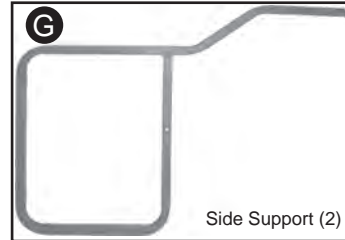
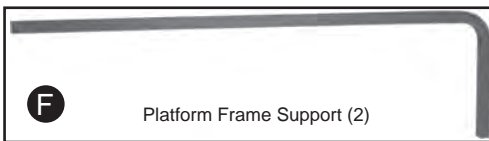
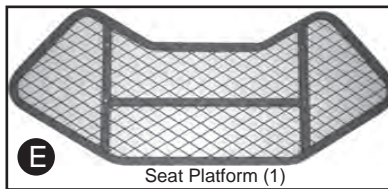
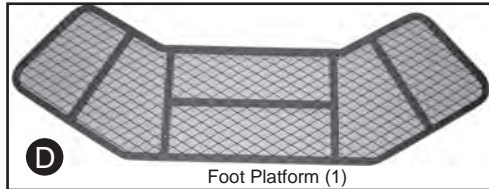
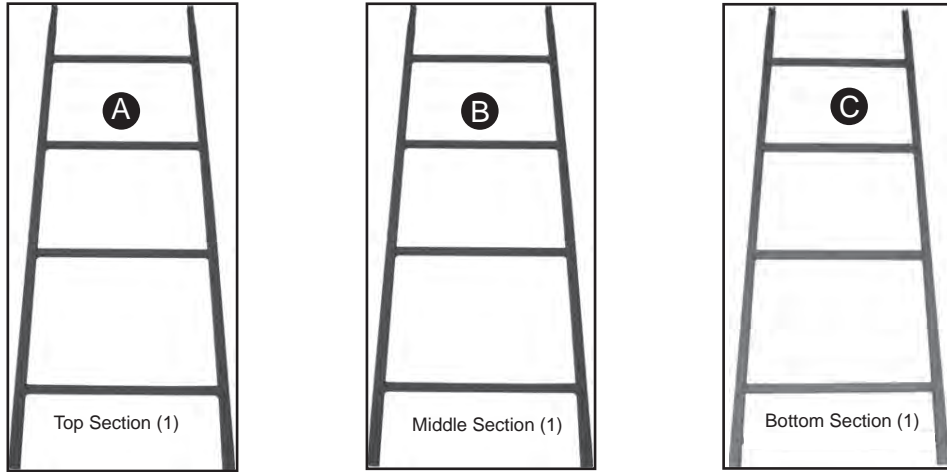

Parts List

A	1 Top Ladder Section	Part # GL-1550
B	1 Middle Ladder Section	Part # GL-2550
C	1 Bottom Ladder Section	Part # GL-3550
D	1 Foot Platform	Part # GP-550
E	1 Seat Platform	Part # GSP-550
F	2 Platform Frame Support	Part # GPFS-550
G	2 Side Support	Part # GSS-550
H	2 Seat Support	Part # GSS-555
J	2 Shooting Rail Support	Part # GSRS-550
K	1 Shooting Rail	Part # GSR-550
L	1 Shooting Rail Cover	Part # GPSC-550
M	2 Platform Brace	Part # GPB-550
N	1 Footrest	Part # GFR-550
O	2 Tree Connection Brace	Part # GTB-550
P	1 Seat Cushion	Part # GSC-550
Q	1 Stabilizer Bar	Part # GSB-500
R	3 Armrest/Footrest Cover	Part # GPAC-550
S	4 Sleeve	Part # GS-100
T	1 Tiedown Rope	Part # TR-1000
U	2 Ratchet Strap	Part # WRA-100
V	2 Installation Strap	Part # ICS-100
X	1 Adjustment Knob	Part # AK-100

Hardware

65	4 M12x65mm Bolt	Part # 1265
60	18 M12x60mm Bolt	Part # 1260
55	14 M12x55mm Bolt	Part # 1255
45w	1 M12x45mm Bolt w/wingnut	Part # 1245W
	2 Harness	Part # 2001
	6 M10 Quickclip	Part # 1615

Hardware Pack

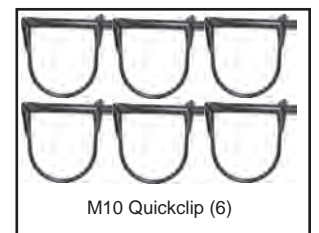
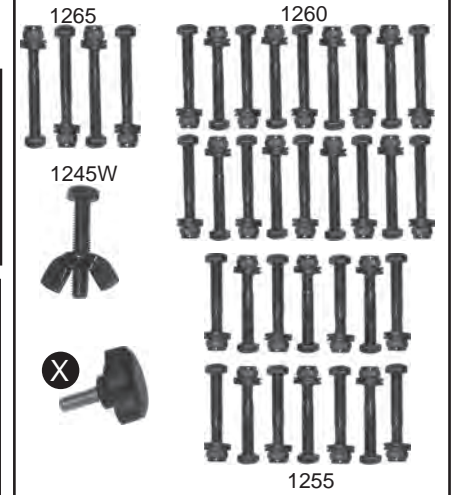

NOTE: ALL WASHERS ARE AGAINST THE BOLT HEAD AND THE NUT UNLESS STATED OTHERWISE

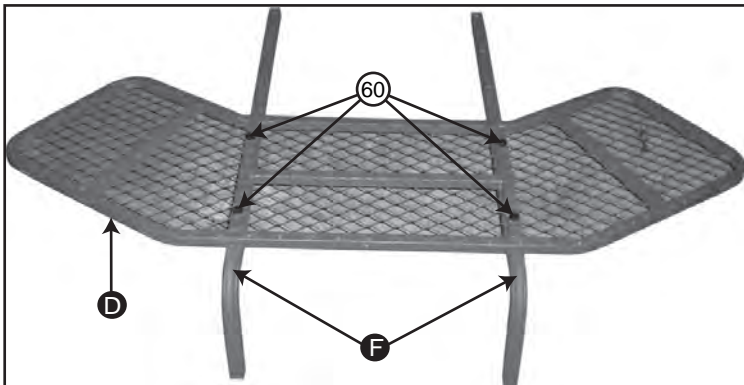

1. Attach Foot Platform **D** to the front of Platform Frame Supports **F** using **4-M12x60mm bolts**.

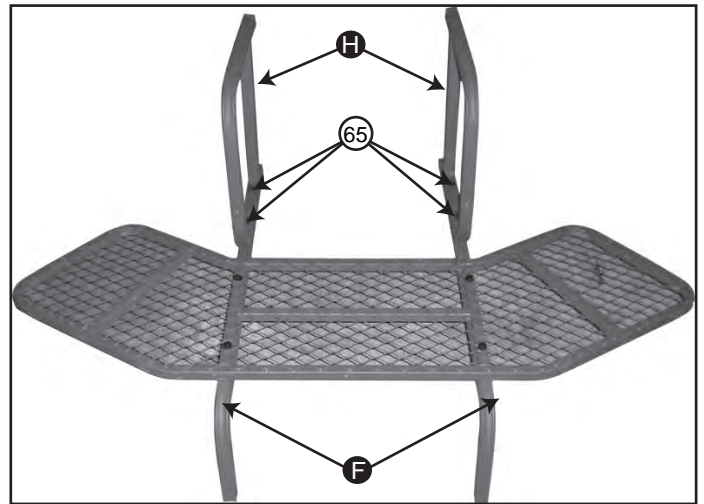

2. Attach one Seat Support **H** to the rear of each Platform Frame Support **F** using **2-M12x65mm bolt** on each side.

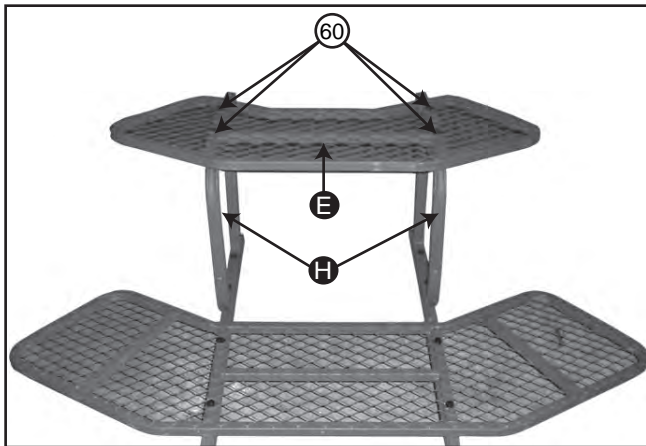

3. Attach Seat Platform **E** to the top of Seat Supports **H** using **4-M12x60mm bolts**.

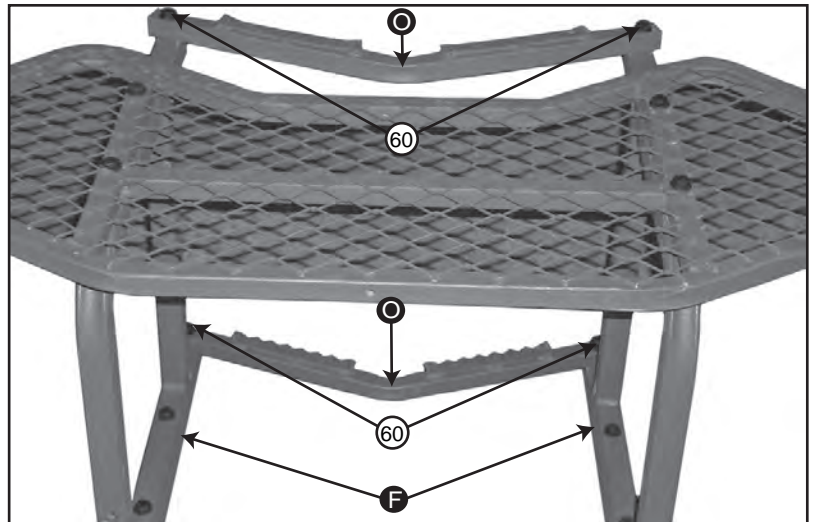

4. Attach one Tree Connection Brace **C** to the upper part of Seat Support **H** just behind the Seat Platform using **2-M12x60mm bolts**.

Attach the other Tree Connection Brace **C** to the lower part of Seat Support **H** using **2-M12x60mm bolts**.

NOTE: ALL WASHERS ARE AGAINST THE BOLT HEAD AND THE NUT UNLESS STATED OTHERWISE

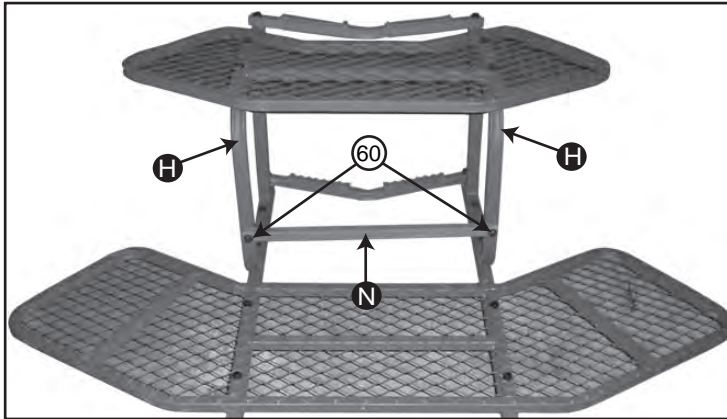

5. Attach Footrest **N** to the front of Seat Supports **H** using **2-M12x60mm bolts**.

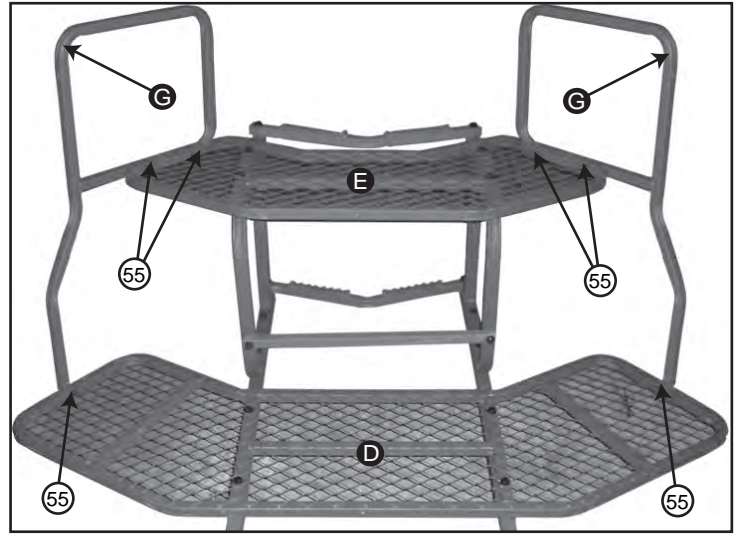

6. Attach angled bar of Side Support **G** to the side of Foot Platform **D** using **1-M12x55mm bolt**.

Attach squared part of Side Support **G** to the side of Seat Platform **E** using **2 -M12x55mm bolts**.

Repeat this step for the opposite side.

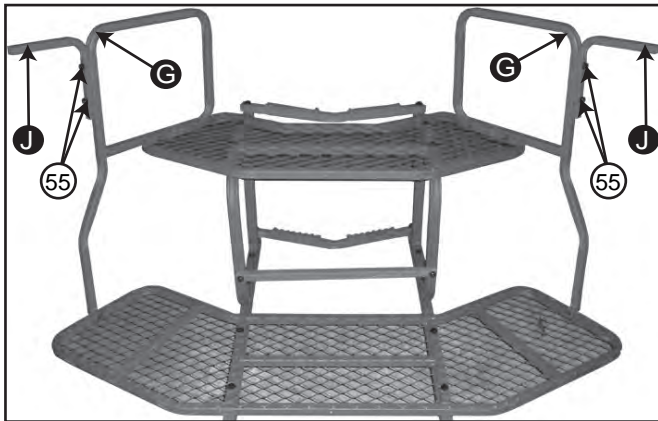

7. Attach Shooting Rail Support **J** to the front of Side Support **G** using **2-M12x55mm bolts** on each side.



8. Attach Shooting Rail **K** to the top of each Shooting Rail Support **J** using **2-M12x55mm bolts** on each side.

NOTE: ALL WASHERS ARE AGAINST THE BOLT HEAD AND THE NUT UNLESS STATED OTHERWISE

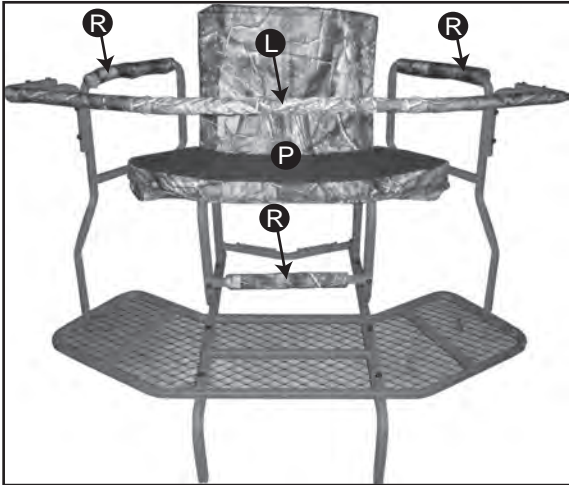

9. Attach Seat Cushion **P** to Seat Platform **E**.

Attach two Armrest Cover **R** to the top of each Side Support **G**.

Attach Footrest Cover **R** to Footrest **N**.

Attach Shooting Rail Cover **L** to Shooting Rail **K**.

10. Facing the rear of the stand, attach each Installation Strap **V** to the upper portion of Seat Support **H**, just behind the Tree Connection Brace. **(See Installation Strap Instructions)**

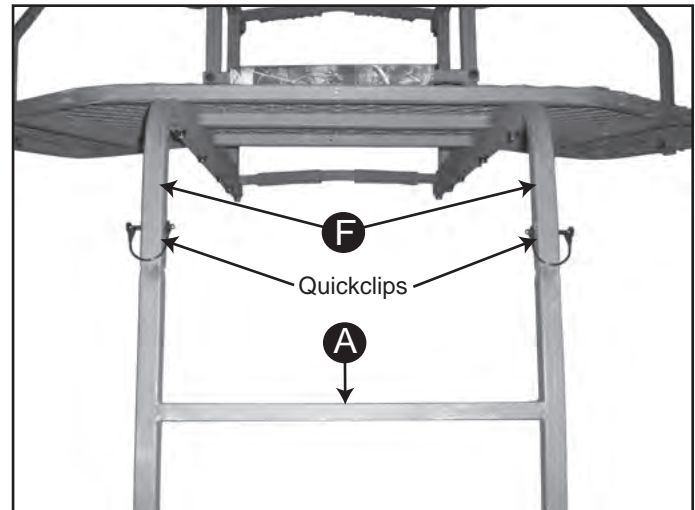
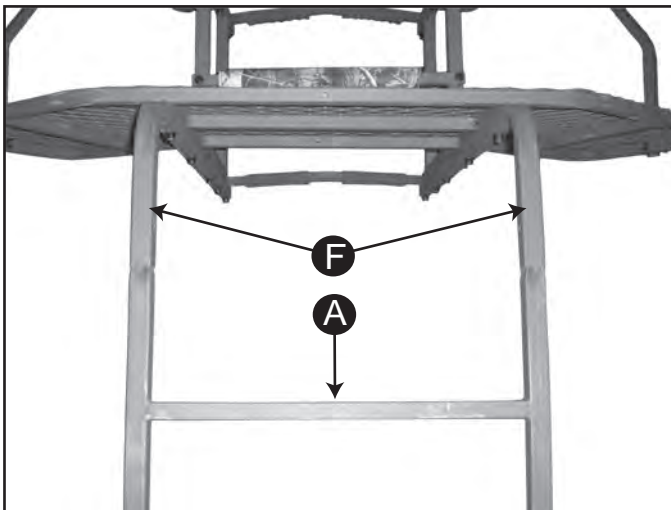

11. Slide Top Ladder Section **A** into Platform Frame Supports **F**.

(The Top Ladder Section has two holes on the sides of the ladder just below the top rung).

12. Insert two Quickclips through the Platform Frame Support **F** and Top Ladder Section **A**. Close the Quickclips to secure.

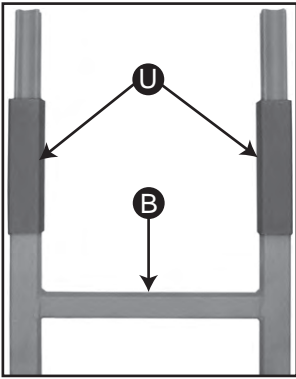

13. Slide Sleeves **U** over the crimps of Ladder Section **B**.

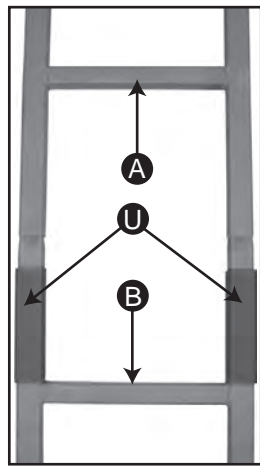

14. Insert Ladder Section **B** into Top Ladder Section **A**.



15. Slide the Sleeves over the joint where ladder sections are connected.

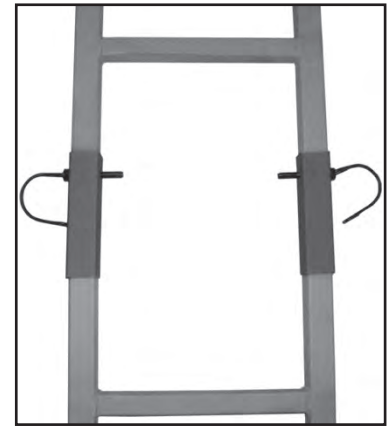

16. Insert 1 - **Quickclip** through the hole on the sleeve, and through the ladder sections on each side of the ladder.

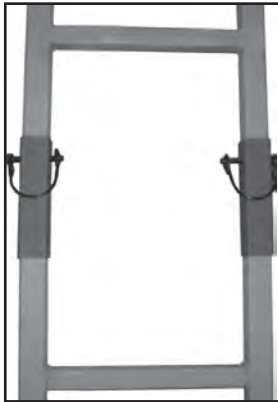

17. Close the quickclip to secure the ladder sections together.

18. Follow **Steps 13-17** to attach the bottom section to the middle section.

NOTE: ALL WASHERS ARE AGAINST THE BOLT HEAD AND THE NUT UNLESS STATED OTHERWISE

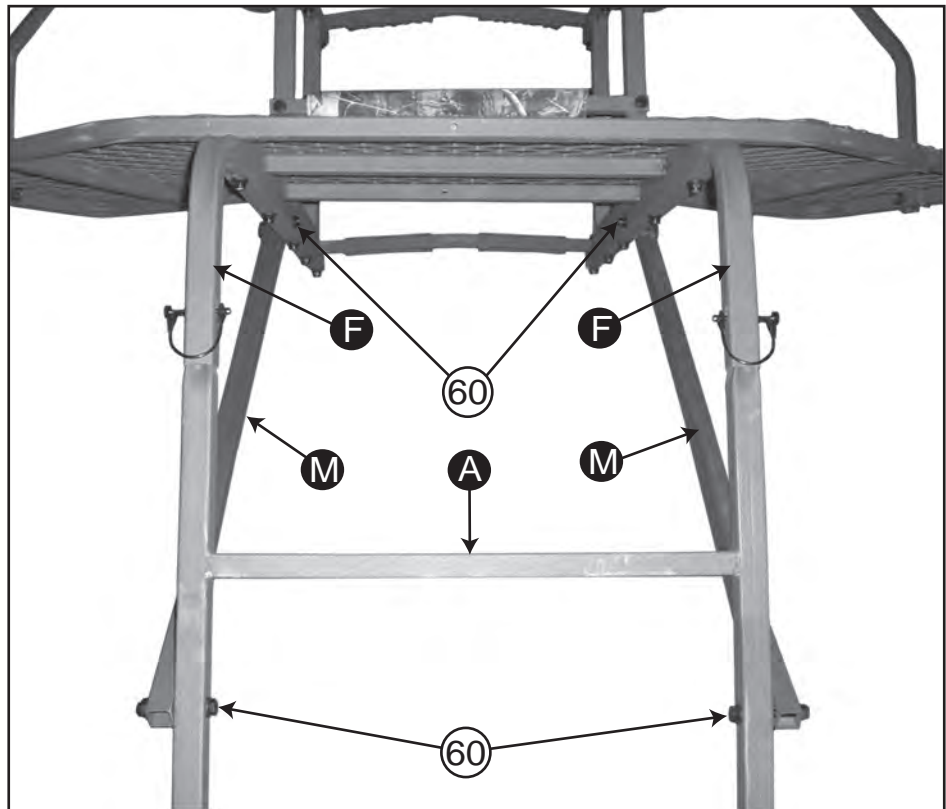

19. Attach Platform Brace **M** to Platform Frame Support **F** using **1-M12x60mm bolt** on each side. Attach the other side of Platform Brace **M** to Top Ladder Section **A**, just below the first rung, using **1-M12x60mm bolt** on each side.

NOTE: NOW THAT TREESTAND IS ASSEMBLED MAKE SURE TO TIGHTEN ALL HARDWARE



1. Attach Ratchet Straps **U** to the outermost corners of each Tree Connection Brace. See Ratchet Strap Instructions.

Attach Installation Straps **V** behind the the upper Tree Connection Brace. See Installation Strap Instructions.

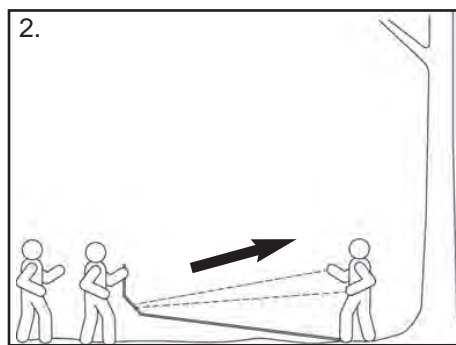

2. Position bottom of stand 4-5 feet from base of tree.

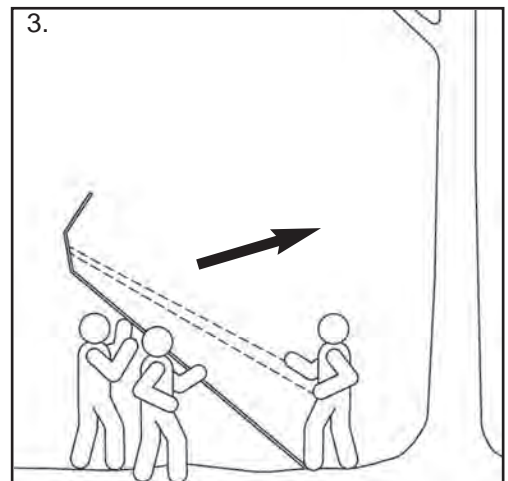

3. One person will stand at the base of ladder with his/her foot on bottom rung while holding installation straps. This will prevent tree stand from sliding. Two people will stand at opposite ends of tree stand, facing Platform and slowly walk tree stand upward using rungs of ladder.

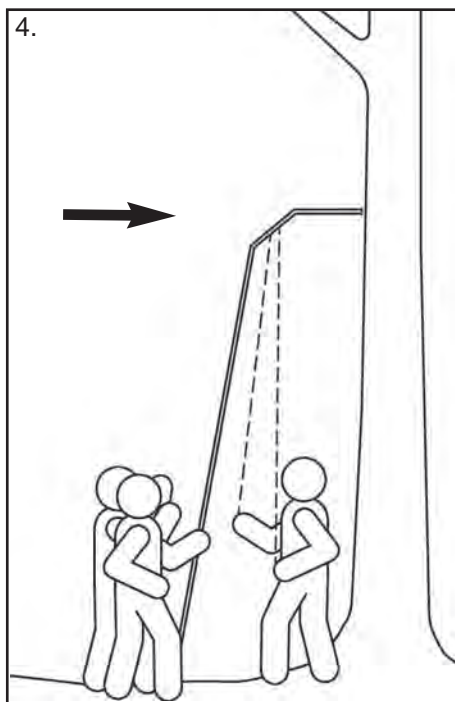

4. As tree stand is being raised, the person holding Installation Straps will pull toward themselves to take up slack. It will steady and ease the weight of stand on the other two people. Continue walking stand upward, until Tree Contact is resting against the tree.

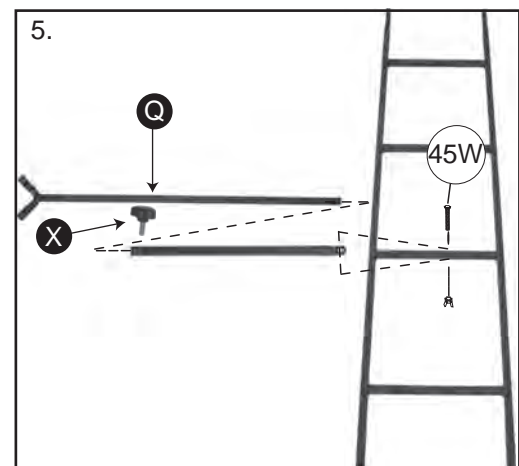

6. Slide the inner part of the Stabilizer Bar into the outer part. Attach Stabilizer Bar **Q** to the second rung of the Middle Ladder Section with 1 - **M12x45W bolt and 1 wingnut**.

Insert the Adjustment Knob **X** in the Stabilizer bar at the proper adjustment point to the tree.

NOTE: Drawings are for illustration purposes only. Drawings may not depict actual product.

WARNING Installation Straps, Stabilizer Bar and Ratchet Straps **MUST** be secured prior to climbing the treestand.

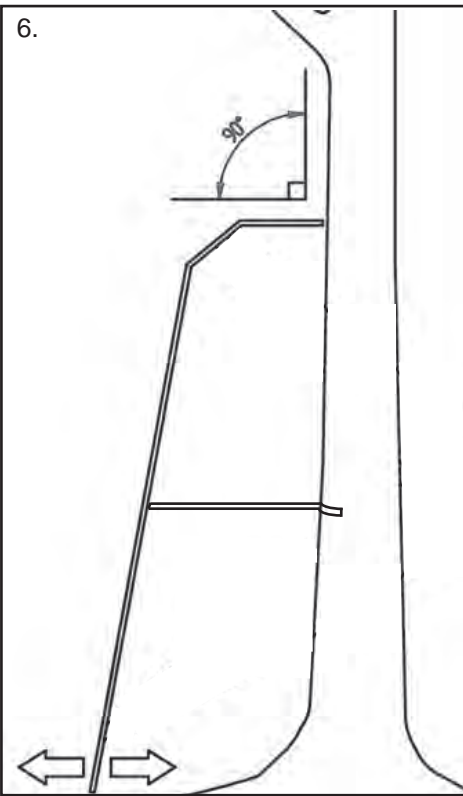

6. Move base of ladder toward or away from tree slightly in order to make Platform as parallel to the ground as possible.

Apply your full weight to the first step so it settles into the ground.

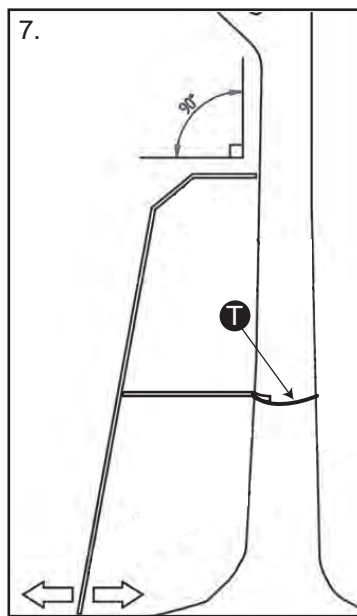

7. Slide the inner part of the Stabilizer Bar into the outer part. Position the Stabilizer Bar **ⓐ** to the second rung of the middle ladder section with **1-M12x45mm bolt with wingnut**.

Position the Stabilizer bar against the tree.

Tie Tiedown Rope **ⓐ** just behind the brace of the inner part of Stabilizer Bar.

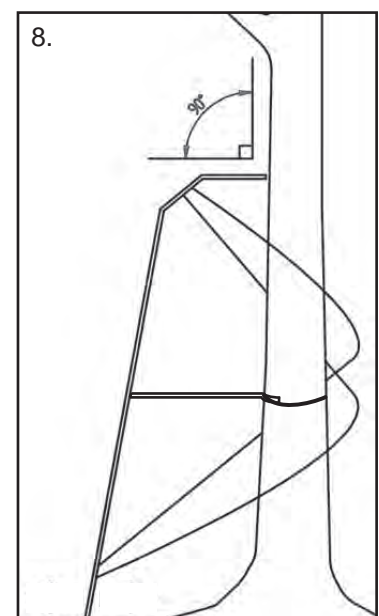

8. Cross Installation Straps behind tree. Attach to the bottom ladder section by following **Installation Strap Instructions**.



9.

9. After the ladder stand has been secured to the tree with the installation straps, and the stabilizer bar has been securely attached to the tree, continue to have two people hold the ladder, climb cautiously up to the platform. Once you reach the top, **IMMEDIATELY ATTACH YOUR SAFETY HARNESS TO THE TREE**. Keep the tether strap above your head.

10. Cautiously climb to the top of the treestand. Wrap the strap of the ratchet around the back of the tree once, and thread it through the ratchet. **(See Detailed Ratchet Strap Instructions)**.

Repeat Step 10 for the other Ratchet.

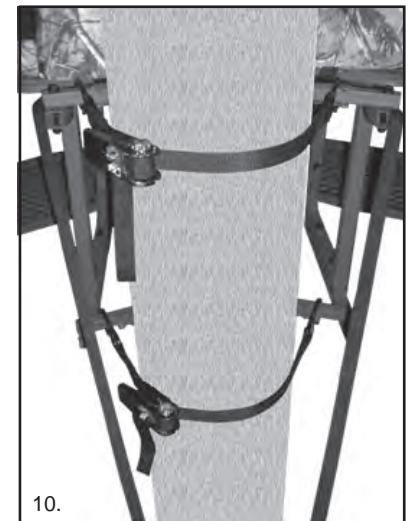

10.

⚠ WARNING
Installation Straps, Stabilizer Bar and Ratchet Straps **MUST** be secured prior to climbing the tree stand.

⚠ WARNING DO NOT sit on seat platform until the ratchets have been secured.

Installation Strap Instructions

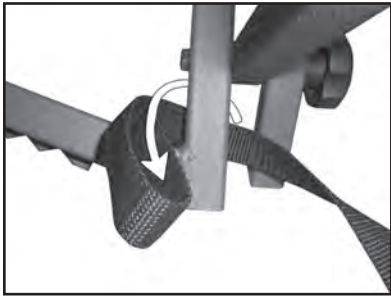

1. Place looped end of strap under platform.

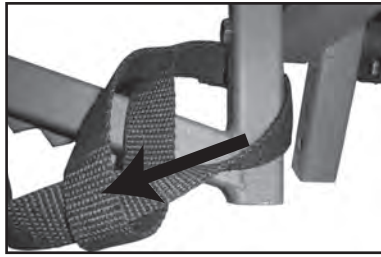

2. Insert loose end of strap through the loop.

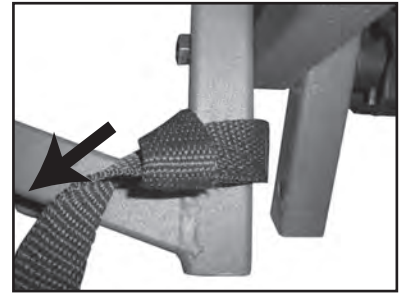

3. Pull to tighten. Continue with these steps to install the other strap on the other side of the platform.

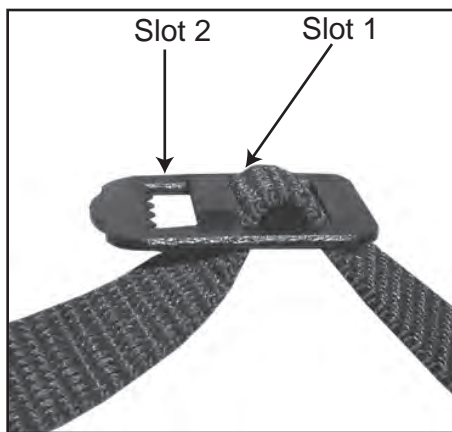

4. Place loose end of strap with clip, under the top rung of the bottom ladder section.



5. Insert the strap through Slot 1 on the clip.



6. Insert the strap through the Slot 2 with the teeth.

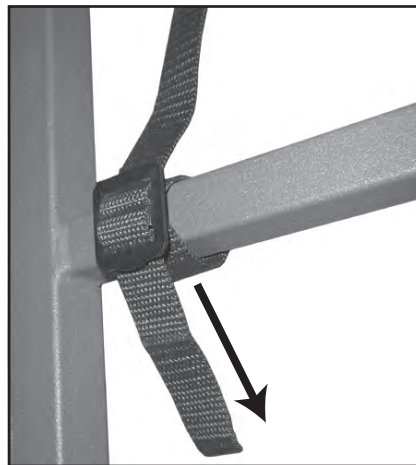

7. Pull strap to tighten.

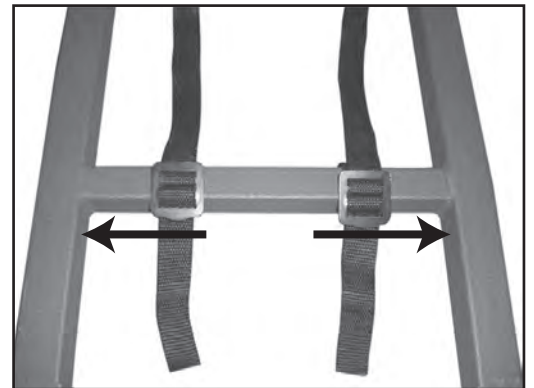

8. Slide the buckles out to the sides to create tension on the straps.

⚠ WARNING DO NOT sit on seat platform until the ratchet and installation straps have been secured.

Ratchet Strap Instructions

You **MUST** follow these instructions prior to installation

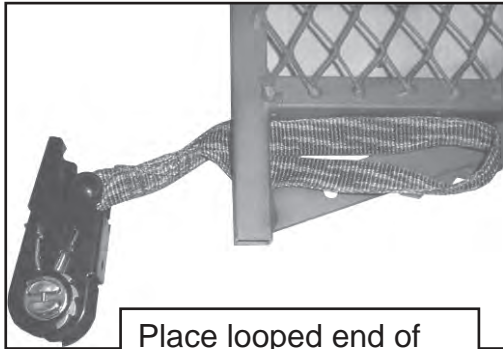

Place looped end of Ratchet under platform

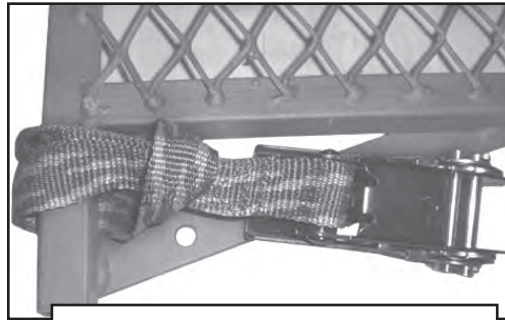

Insert ratchet through loop

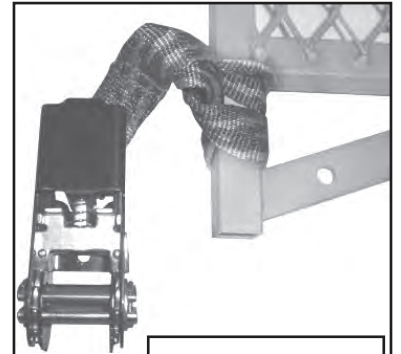

Pull to tighten

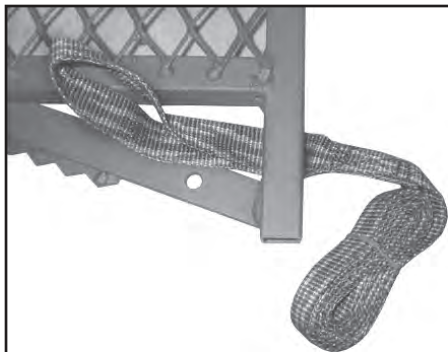

Place looped end of strap under platform

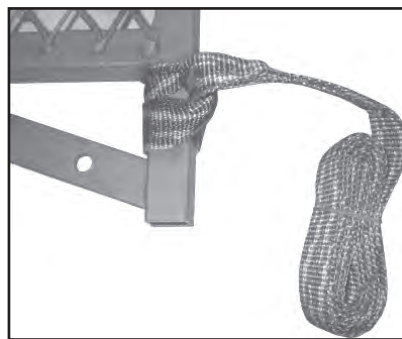

Insert strap through loop

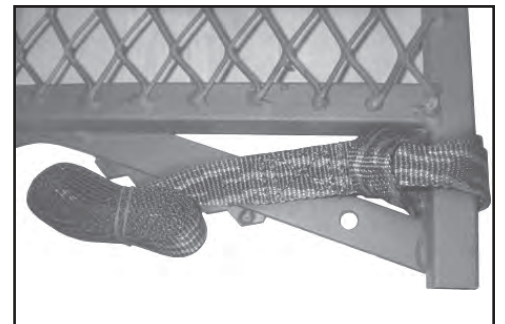

Pull to tighten

Detailed Ratchet Strap Instructions

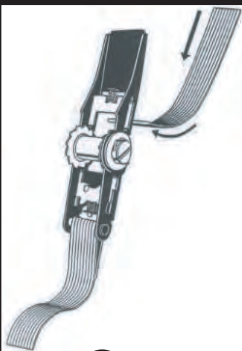

1

Open ratchet handle flat and insert end of strap through opening.

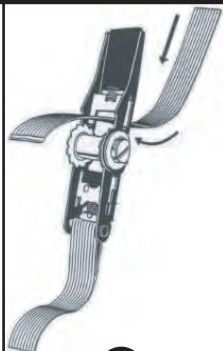

2

Pull Strap through opening

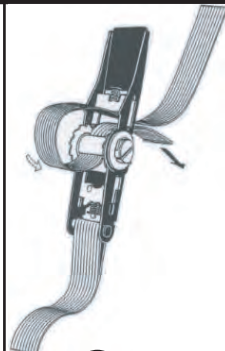

3

Insert end of strap through slot in ratchet wheel.

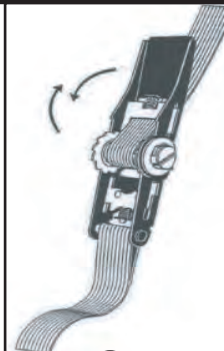

4

Ratchet handle back and forth to tighten strap

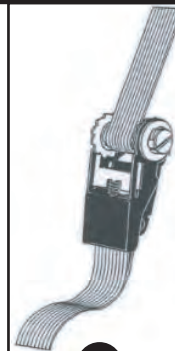

5

After strap is tight, close handle to the locked position

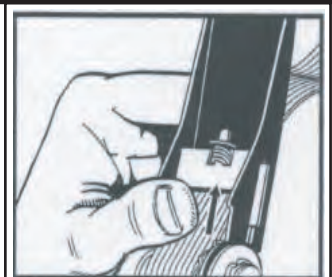

6

To release tension, push spring loaded retaining lock and simultaneously pull on strap.