

**MODEL: ASHO-205
BASIC HANG-ON**

- Always Wear a Safety Harness with this Product
- Practice Using at Ground Level
- Weight Limit: 300 lbs.
- Tree Size: 9"-18" diameter

Remington®



THANK YOU! for purchasing Remington's Basic Hang-On by Tahsin Industrial Corp USA.

⚠ Warning

Every year serious injury and even death occurs from hunting related falls. To ensure your safety, please **COMPLETELY** read and follow this safety manual and **ALL** warning labels **BEFORE** assembling, installing or utilizing this product.

DO NOT USE THIS PRODUCT BEFORE FULLY UNDERSTANDING ALL SAFETY WARNINGS AND INSTRUCTIONS. IF YOU HAVE QUESTIONS, ARE UNSURE ABOUT ANY INFORMATION OR NEED ADDITIONAL INFORMATION CONCERNING YOUR PRODUCT, CONTACT OUR CUSTOMER SERVICE DEPARTMENT AT 1-866-972-6168 OR VISIT **WWW.TREESTANDCUSTOMERSERVICE.COM**. KEEP AND MAINTAIN THIS SAFETY AND INSTRUCTION MANUAL IN A SAFE LOCATION FOR FUTURE REFERENCE.

TREESTAND SAFETY WARNINGS

Please read the following instruction manual and warnings labels completely before utilizing this product. Failure to understand and execute the instructions and warnings may result in serious injury or death. In the event of an accident, have a plan for rescue, including the use of devices that may be easily reached while suspended.

ALWAYS read and understand all warnings and instructions and use all safety products provided before each use of this product. Failure to read and understand all warnings and instructions may result in serious injury or death. Contact a Customer Service Representative with any questions you may have.

NEVER exceed total weight limit of **300 lbs.** **DO NOT** use if your combined weight with all of your hunting gear and any accessories exceeds **300 lbs.** Use of tree stand over the weight limit may result in serious injury or death.

ALWAYS wear a Fall Arrest System (FAS) (Harness) consisting of a full body safety harness with lineman's belt after leaving the ground. You **MUST** stay connected at all times after leaving the ground while using climbing aids, hang-ons and climbing tree stands. Single safety belts and chest harnesses are no longer allowed and should **NEVER** be used. If you are not wearing a Full Body Harness properly attached to the tree, that is protecting you from a fall, **DO NOT leave the ground.** Failure to wear your Full Body Harness may result in serious injury or death. Falls can occur at anytime after leaving the ground.

ALWAYS use a Full Body Safety Harness when using this tree stand. A TMA Certified Full Body Harness with lineman's belt must always be connected to yourself and the tree during ascending, hunting and descending. The use of a lineman's belt is **REQUIRED AT ALL TIMES** during ascending, hunting and descending the tree stand. When using a lineman's belt to ascend the tree, the full body harness **MUST** be attached to the tree before stepping onto the tree stand. The length of the harness tether strap must be minimized at all times. It should be adjusted so that it is above the head with no slack in the sitting position and you should have the minimum amount of slack possible when climbing.

ALWAYS inspect the tree stand and the Fall Arrest System (FAS) (Harness) for signs of wear or damage **BEFORE** each use. Also inspect to ensure that nuts and bolts are secure. Pay special attention to the harness and straps, guaranteeing that nothing has been frayed or severed. Destroy all products that cannot be repaired by the manufacturer. Contact a Customer Service Representative for replacement parts. The Fall Arrest System **MUST** be discarded and replaced after a fall has occurred.

ALWAYS read and understand the manufacturer's warnings and instructions on how to use and properly adjust the harness. Attach your Full Body Harness in the manner and method described by the manufacturer. Beware of hazards associated with Full Body Harnesses and the fact that prolonged suspension in a harness may be fatal. Have in place a plan for rescue, including the use of cell phones, or signal devices that may be easily reached while suspended. If rescue personnel cannot be notified, you must have a plan for recover/escape. If you have to hang suspended for a period of time before help arrives, exercise your legs by pushing against the tree or doing any other form of continuous motion. Failure to recover in a timely manner could result in serious injury or death. If you do not have the ability to recover/escape, hunt from the ground.

DO NOT use tree stand if any nuts or bolts or parts are loose, bent, or crooked.

NEVER let children play with or use this treestand without adult supervision. This treestand is not a toy.

DO NOT use this tree stand while under the influence of alcohol, medication or any illegal substances. Use of tree stand while under the influence of any of these substances may result in serious injury or death.

NEVER use this treestand during inclement weather. **DO NOT** use tree stand during thunderstorms, snowstorms, hurricanes, tornadoes or any other weather conditions that include (but not limited to) lightning, icy conditions, or high winds that could create slippery or dangerous situations. End your hunt and return to the ground if inclement weather conditions arise.

NEVER use this tree stand if you have a history of health problems such as (but not limited to) heart problems, back problems, high blood pressure, impaired vision, equilibrium impairments, are afraid of heights, have been advised by a doctor or physician not to climb. If you are not physically fit, well rested, and alert, or if you have any other physical or mental condition that would impair your ability to properly use this treestand.

NEVER use treestand if you are feeling ill, nauseous, dizzy or if you have a prior condition that could cause a problem. i.e., heart condition, joints that lock-up spinal fusions, etc. or if you are not well rested and alert. Physical ailments can reduce your ability to safely install, utilize, and remove your treestand. Please consult a physician prior to use.

NEVER wear jewelry or loose fitting clothing, which can cause hazardous conditions. Clothing may be caught in your equipment and cause you to fall. You must always wear non-slip or rubber boots. Shoelaces must be tucked into your boots. Rings and necklaces **MUST NOT** be worn.

NEVER use this tree stand on a tree that is dead, leaning, diseased, loose barked or on a utility pole as the tree may fall, break, or uproot and may result in serious injury or death.

NEVER transport any of your equipment with yourself while ascending or descending the tree. You will need to have two hands free during ascending and descending for safety. Use a haul line to pull up your firearm (unloaded, chamber opened with safety lock engaged, barrel facing towards the ground), bows, arrows, knives or any other equipment to your tree stand once you have reached your desired hunting height. **ONLY** pull up hunting equipment after the tree stand has been secured to the tree and after you and your harness have been secured to the tree. Prior to descending, lower your equipment on the opposite side of the tree from which you are climbing. Make sure that the unloaded firearm's safety lock is engaged and the gun barrel is pointing towards the ground.

ALWAYS hunt with a plan and a buddy. Before you leave home, let others know your exact location, when you plan to return and who is with you.

ALWAYS inform someone of the hunting location, where the treestand is located and the expected duration of the hunt.

TREESTAND SAFETY WARNINGS

ALWAYS carry emergency signal devices such as a cell phone, walkie-talkie, whistle, signal flare, PLD (personal location device) and flashlight with you at all times and within reach even while you are suspended in your harness. Watch for changing weather conditions. In the event of an accident, remain calm and seek help immediately.

NEVER modify your treestand in any way by making repairs, replacing parts, or altering adding or attaching anything to it except if explicitly authorized in writing by the manufacturer. Improper installation or adjustment may cause serious injury or death. Remove all contents from box. Inspect for any damaged or missing parts. If any parts are missing or damaged, you must only use certified replacement parts. Using any other replacement parts will void product warranty. **THERE ARE NO EXTRA PARTS.** All parts **MUST** be used to ensure the safety of you and your stand. If you think parts are missing or damaged, **STOP IMMEDIATELY** and contact our Customer Service Department. Using the tree stand with missing or damaged parts may result in serious injury or death. Contact a Customer Service Representative if you have any missing, damaged or extra parts.

PRACTICE installing, adjusting and using your tree stand at ground level prior to using it at an elevated position.

Correct tightening and adjustments of chains, cables, straps, etc. are critical to stable hang-on installation. All tree stand contact points **MUST** be in contact with the tree before you step down on your tree stand.

ALWAYS have a minimum of three people present when installing or removing this treestand.

NEVER use this treestand with a second person. The treestand is designed for use by **ONE** person.

ALWAYS know your physical limitations. Don't take chances. If you start thinking about how high you are, don't go any higher. Instead, choose a minimum height that will allow for safe, effective and comfortable hunting.

NEVER use this treestand for any use other than hunting. Our treestands are designed for hunter's to wear a Full Body Harness. If you are not completely comfortable and confident with your ability to safely install, ascend, hunt and descend using a Full Body Safety Harness and this treestand, **DO NOT PROCEED.**

ALWAYS lean **forward towards the tree** as you climb. **NEVER** lean out from the treestand for any reason.

NEVER use this treestand for trimming trees.

NEVER rely on a branch for support.

NEVER jump or bounce on the treestand's platform or ladder sections to seat it to the tree.

NEVER fall asleep in your stand as you may fall out resulting in serious injury or death.

NEVER adjust your stand while in use. **ALWAYS** ensure that you and your treestand are safely secured to a healthy tree. Your tree stand **MUST** be attached tightly to the tree and secured in place. If the stand is not secure, it may shift while in use, resulting in serious injury or death.

ALWAYS keep instructions in a safe place and review before each use. It is the responsibility of the treestand owner to furnish the complete instructions to anyone who borrows or purchases the treestand from you.

ALWAYS be sure to retighten all bolts **BEFORE** each new use of treestand.

DO NOT leave your treestand outside. It must be stored inside when not in use.

DO NOT carry the stand when ascending or descending the tree. Use a haul line to raise and lower your stand.

Climbing aids such as stick ladders, sectional ladders, steps or such **MUST** extend above the platform of the hang-on to allow the user to step down on the platform. **NEVER** step up to the platform. When using a climbing belt to ascend the tree, the Full Body Harness should be attached to the tree before stepping down into the treestand.

NEVER remove any safety warning stickers from this product. Safety must be your first priority during the use of this product.



WARNING

DO NOT use this tree stand without reading and following all warnings and instructions before each use. Failure to do so may result in serious injury or death.

ALWAYS inspect your tree stand before each use and **DO NOT** use if parts are missing, worn, or damaged.

ALWAYS wear a Full Body Harness while using this treestand. Failure to wear a full body harness while using this tree stand may result in serious injury or death.

DO NOT exceed the tree stand **300 lbs.** weight limit which includes your body weight, all the weight of your clothes and gear. Exceeding the tree stand weight limit may cause the tree stand to break or resulting in serious injury or death.

NEVER stand on tree stand seat, footrest, armrest, or shoulder rail. Standing on any of these parts may cause the tree stand to break or fail resulting in serious injury or death.

NEVER make alterations or modifications to the tree stand. Doing so may result in serious injury or death and void all warranties.

NEVER use the tree stand if the tree is dead, diseased, leaning, a wet or uneven surface, and a tree may fall, break, or result in serious injury or death.

NEVER use tree stand during inclement weather. **DO NOT** use tree stand during thunderstorms or any other weather condition including (but not limited to) lightning, freezing rain, high wind that could create a slippery or dangerous condition.

DO NOT use tree stand under the influence of alcohol, drugs, or medication. Using tree stand under the influence of alcohol, drugs, or medication may result in serious injury or death.

NEVER use tree stand if you have dizzy spells, a heart problem, are afraid of heights, have been advised by a doctor or other health care provider not to climb, or have any condition that would impair your ability to climb up or down or use tree stand as it could result in serious injury or death.

NEVER remove or deface tree stand warning labels. Replacement labels can be obtained from the address below.

Tahsin Industrial Corp USA 685 Route 10 East - Randolph, NJ 07869 - Visit www.treestandcustomerservice.com or 1-866-972-6168 - Manufactured in the year XXXX

Item# ASHO-205

MODEL: ASHO-205A BASIC HANG-ON

- Always Wear a Safety Harness with this Product
- Practice Using at Ground Level
- Weight Limit: 300 lbs.
- Tree Size: 9"-18" diameter

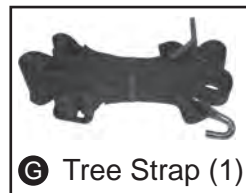
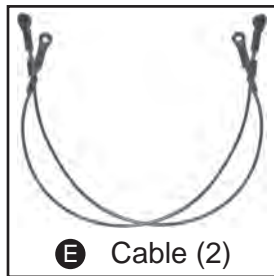
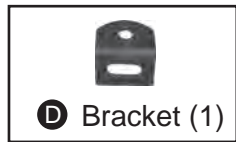
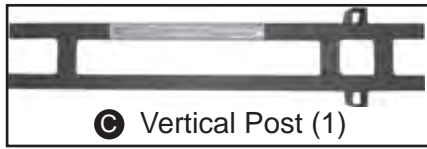
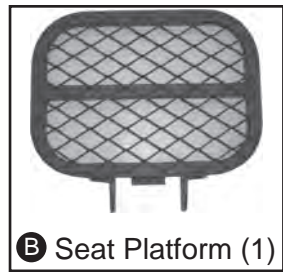

Parts List

A	1 Platform	Part # WP-2000
B	1 Seat Platform	Part # WSP-200
C	1 Vertical Post	Part # WVP-200
D	1 Bracket	Part # WB-200
E	2 Cable	Part # WC-200
F	1 Seat Cushion	Part # WSC-205
G	1 Tree Strap	Part # WTS-200
H	2 Backpack Strap	Part # WBP-100
J	1 Buckle Strap Assy	Part # WBA-100
ⓐ	4 M12x40mm Bolt	Part # 1240
ⓑ	2 M12x45mm Bolt	Part # 1245
ⓒ	2 M12x50mm Bolt	Part # 1250

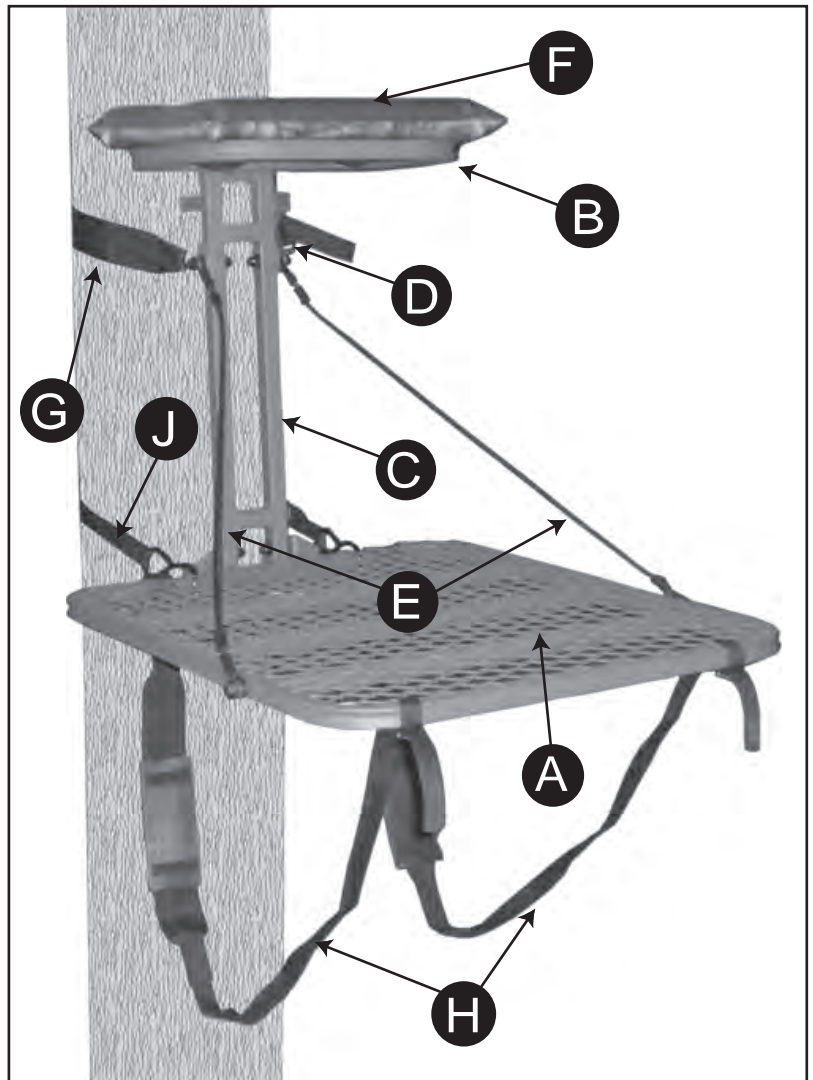

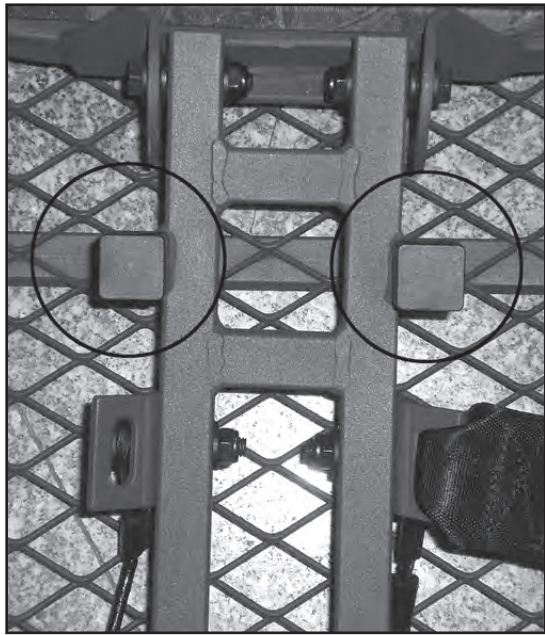

⚠ WARNING ⚠

This stand comes with caps covering the teeth that go against the tree. This is for packaging purposes only. You **MUST** remove these caps when installing the stand.

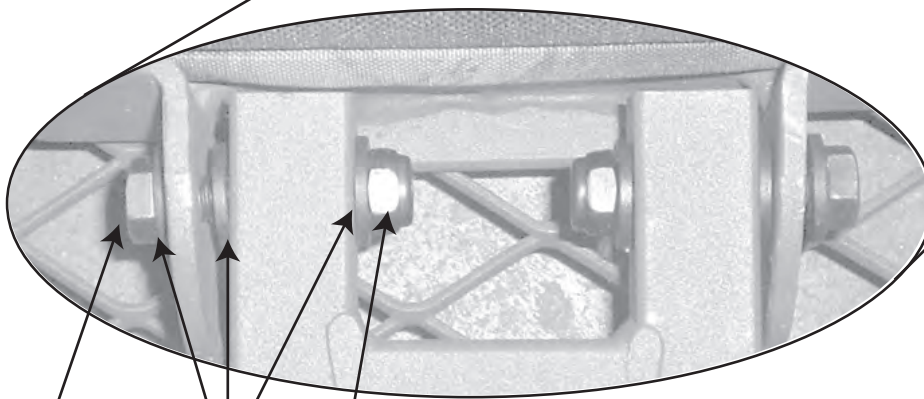
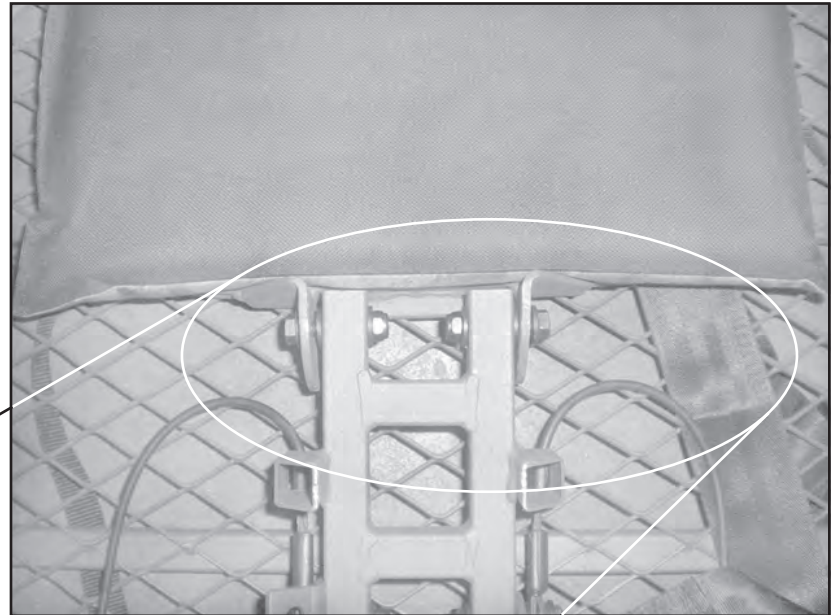

Bolt Head
Washer
Nut

Attach Seat Platform **B** to Vertical Post **C** using one **1 - M12x40mm bolt** on each side.

Insert a washer on the bolt, insert the bolt through the bracket on the seat platform, insert another washer, then insert the bolt through the vertical support. Insert the last washer and tighten with the nut. Do this on both sides of the seat platform.

Attachment Instructions

MODEL: ASHO-205
BASIC HANG-ON

STEP 1: While wearing your safety harness, connect your climbing belt to the tree following manufacturer's instructions. Climb to the desired height using your climbing aid. Once you have reached the desired height, hoist your treestand into position.



STEP 2: With the treestand in the folded position, wrap Tree Strap around the tree once and hook the other end into the tree strap bracket. (See Fig.1 and Fig. 2.) Ensure that the strap is not twisted and is laying flat against the tree.

This should be done beneath where your climbing belt is attached to the tree so that your climbing belt is above the treestand.

STEP 3: Pull the excess strap to secure the stand to the tree, as shown in Fig. 3. The stand should be tight to the tree as shown in Fig. 1.

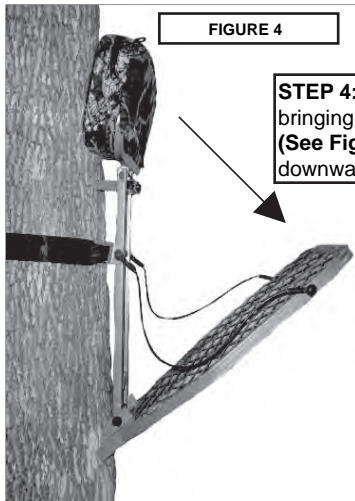
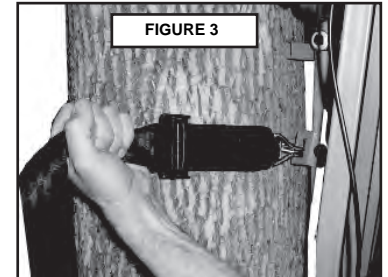
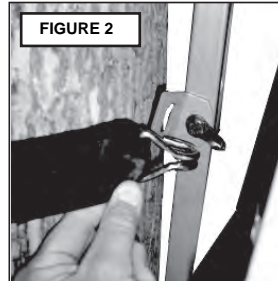

STEP 4: Unfold the stand by bringing the platform downward (See Fig.4) Pull seat platform downward and adjust seat.

STEP 5: Insert the hooked end of the buckle strap assembly into the mesh of the foot platform near the vertical post. Wrap the strap around the back of the tree once and insert the other end of the strap assembly into the mesh of the foot platform near the vertical post. Pull excess strap to tighten.

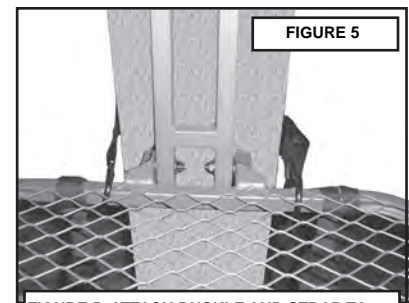

FIGURE 5: ATTACH BUCKLE AND STRAP TO FOOT PLATFORM TO SECURE STAND TO TREE



STEP 6: When moving from your climbing aid to your Hang-On Tree Stand, step down from the aid to the stand as shown in Fig. 6. **Cautiously** put your weight on the stand's platform. The additional weight will create tension on the tree attachment strap and cables.

⚠ WARNING

DO NOT LIFT THE FOOT PLATFORM WHILE THE STAND IS IN USE. LIFTING THE FOOT PLATFORM COULD CAUSE YOUR STAND TO SHIFT, RESULTING IN SERIOUS INJURY OR DEATH. YOU MUST ALSO WEAR A SAFETY HARNESS AT ALL TIMES WHILE THE STAND IS IN USE, INCLUDING CLIMBING AND DESCENDING. FAILURE TO DO SO COULD RESULT IN SERIOUS INJURY OR DEATH.

CAUTIOUSLY put your weight on the stand's platform
The additional weight will create tension on the tree strap and cables.

CHOOSING A SAFE TREE

ALWAYS thoroughly inspect the tree before installing your product. **DO NOT** install your Hang-on on to any dead or unsafe tree, telephone, or utility pole, structural column, or man-made structure. Doing so may result in serious injury or death.

ALWAYS select the proper tree for use. Select a live straight tree that fits within the size limits recommended (minimum diameter must be no less than 9" and maximum 18")

DO NOT select a tree in the dark or choose a tree in close proximity to a fence. You must not have any stumps or rocks beneath your tree.

NEVER use treestand on a tree that is dead, diseased leaning or on wet or uneven ground as the tree may fall, break, or uproot.

- Your tree must not be wet, icy, slippery or on wet, swampy, or loose ground that allows the tree to be unstable.
- You must have a level platform. Your tree must not lean or have an irregular shape.
- Your tree must not have loose or scaly bark or excessive vines. Any surrounding trees must not lean or have excessive dead limbs that may fall onto you or your product
- Your tree must not have any nails, screws, or any other sharp objects protruding that may sever the webbing on your product.

NEVER rely on a branch for support.

NEVER HURRY While climbing with a treestand, make slow, even movements no more than ten to twelve inches at a time. Make sure you have proper contact with the tree and/or treestand every time you move. Maintain three points of contact at all times.

Backpack Assembly Instructions

MODEL: ASHO-205
BASIC HANG-ON

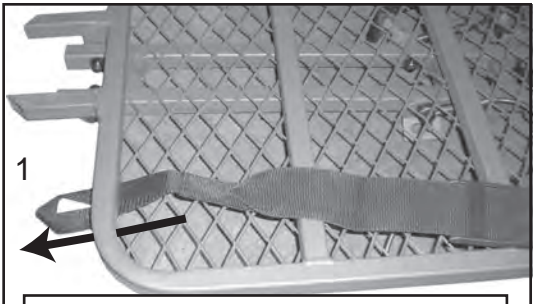

1
Insert looped end of backpack strap through mesh near rear of the foot platform.

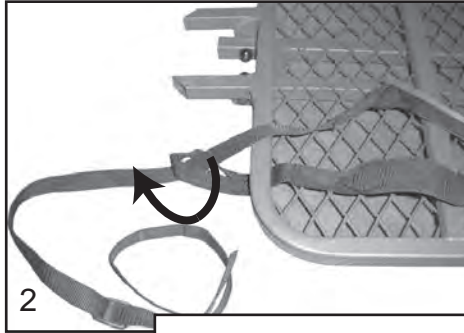

2
Insert other end of strap back through looped end.

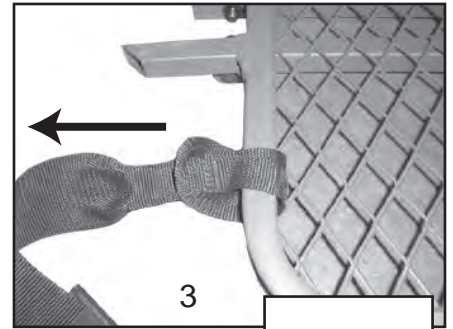

3
Pull tight

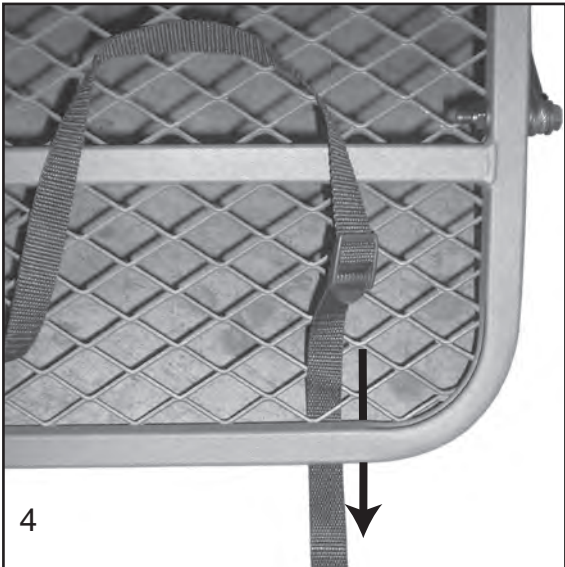

4
Insert loose end of backpack strap through mesh near front of the foot platform.

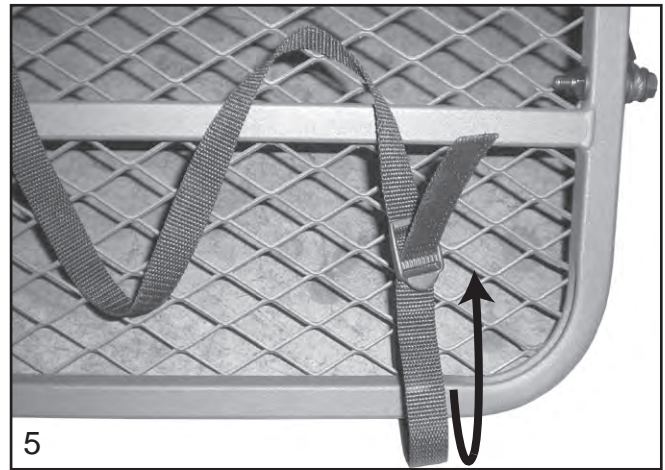

5
Insert end of strap through upper slot of buckle



6
Insert end of strap through lower slot (with teeth) of buckle

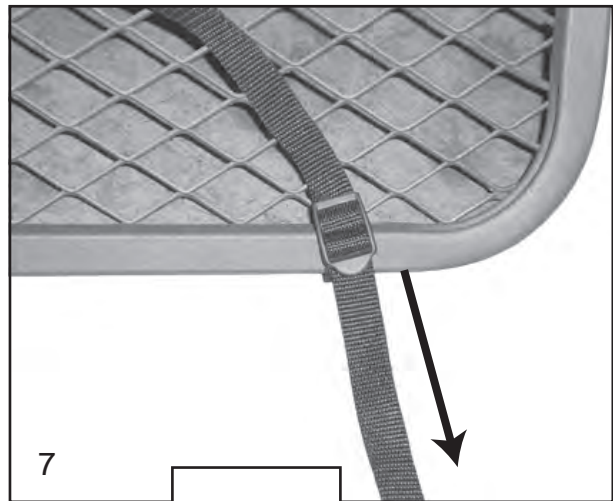

7
Pull tight

Repeat steps 1 through 7 to attach the other strap to the foot platform

Treestrap Adjuster Instructions

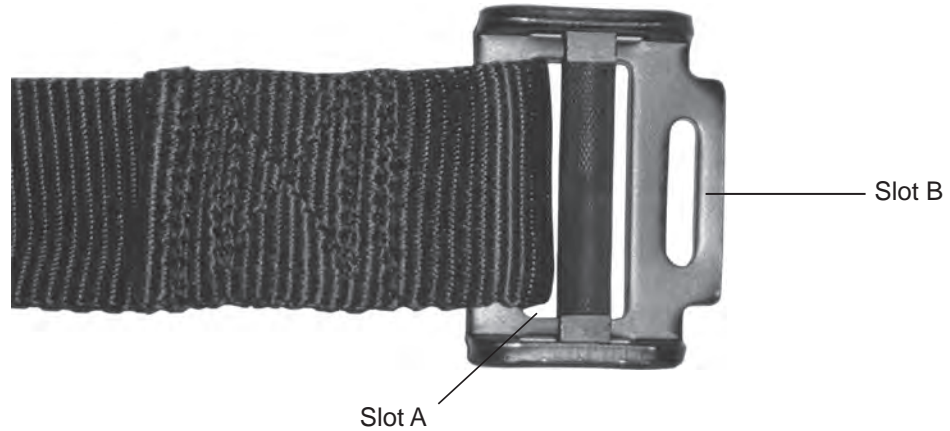

1) Identify webbing slots on tree strap adjuster

2) Wrap tree strap around tree ONCE, be sure strap is not twisted or tangled.



3) Insert strap through Slot A.



4) Thread strap through Slot B. Pull to adjust tension.

Detailed Buckle and Strap Instructions

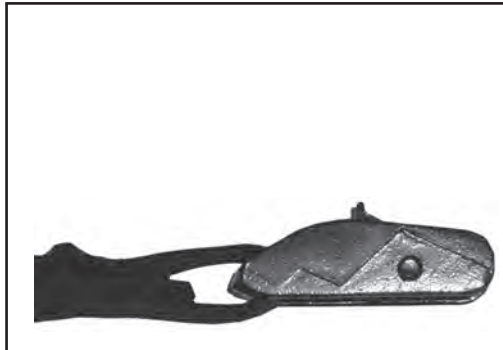

1

Hold buckle as shown

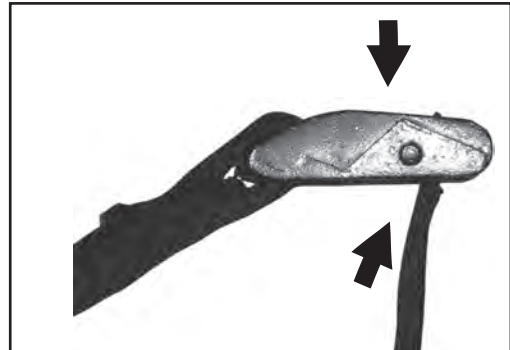

2

Press down on latch and insert strap underneath teeth as shown.



3

Pull strap to desired length.

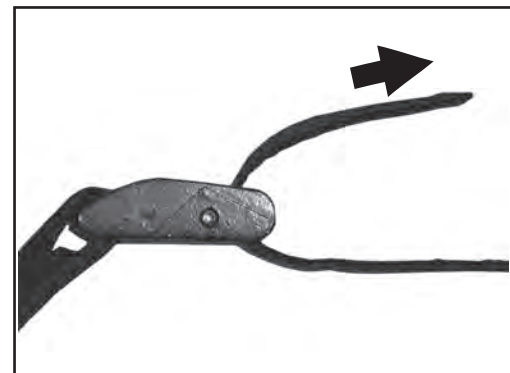

4

Pull slack to tighten.

ALWAYS tug on strap to make sure it is secured by the buckle before use