

**MODEL: 51002**  
**20ft. Stick Ladder**

- Always Wear a Safety Harness with this Product
- Practice Using at Ground Level
- Weight Limit: 300 lbs.
- Tree Size: 9"-18" diameter



**THANK YOU!** for purchasing the 20ft Stick Ladder by Ameristep Inc.

**⚠ Warning**

**Every year serious injury and even death occurs from hunting related falls.** To ensure your safety, please **COMPLETELY** read and follow this safety manual and ALL warning labels **BEFORE** assembling, installing or utilizing this product.

DO NOT USE THIS PRODUCT BEFORE FULLY UNDERSTANDING ALL SAFETY WARNINGS AND INSTRUCTIONS. IF YOU HAVE QUESTIONS, ARE UNSURE ABOUT ANY INFORMATION OR NEED ADDITIONAL INFORMATION CONCERNING YOUR PRODUCT, CONTACT OUR CUSTOMER SERVICE DEPARTMENT AT 1-866-972-6168 OR VISIT [WWW.TREESTANDCUSTOMERSERVICE.COM](http://WWW.TREESTANDCUSTOMERSERVICE.COM). KEEP AND MAINTAIN THIS SAFETY AND INSTRUCTION MANUAL IN A SAFE LOCATION FOR FUTURE REFERENCE.

## TREESTAND SAFETY WARNINGS

Please read the following instruction manual and warnings labels completely before utilizing this product. Failure to understand and execute the instructions and warnings may result in serious injury or death. In the event of an accident, have a plan for rescue, including the use of devices that may be easily reached while suspended.

**ALWAYS** read and understand all warnings and instructions and use all safety products provided before each use of this product. Failure to read and understand all warnings and instructions may result in serious injury or death. Contact a Customer Service Representative with any questions you may have.

**NEVER** exceed total weight limit of **300 lbs.** **DO NOT** use if your combined weight with all of your hunting gear and any accessories exceeds **300 lbs.** Use of tree stand over the weight limit may result in serious injury or death.

**ALWAYS** wear a Fall Arrest System (FAS) (Harness) consisting of a full body safety harness with lineman's belt after leaving the ground. You **MUST** stay connected at all times after leaving the ground while using climbing aids, hang-ons and climbing tree stands. Single safety belts and chest harnesses are no longer allowed and should **NEVER** be used. If you are not wearing a Full Body Harness properly attached to the tree, that is protecting you from a fall, **DO NOT leave the ground.** Failure to wear your Full Body Harness may result in serious injury or death. Falls can occur at anytime after leaving the ground.

**ALWAYS** use a Full Body Safety Harness when using this tree stand. A TMA Certified Full Body Harness with lineman's belt must always be connected to yourself and the tree during ascending, hunting and descending. The use of a lineman's belt is **REQUIRED AT ALL TIMES** during ascending, hunting and descending the tree stand. When using a lineman's belt to ascend the tree, the full body harness **MUST** be attached to the tree before stepping onto the tree stand. The length of the harness tether strap must be minimized at all times. It should be adjusted so that it is above the head with no slack in the sitting position and you should have the minimum amount of slack possible when climbing.

**ALWAYS** inspect the tree stand and the Fall Arrest System (FAS) (Harness) for signs of wear or damage **BEFORE** each use. Also inspect to ensure that nuts and bolts are secure. Pay special attention to the harness and straps, guaranteeing that nothing has been frayed or severed. Destroy all products that cannot be repaired by the manufacturer. Contact a Customer Service Representative for replacement parts. The Fall Arrest System **MUST** be discarded and replaced after a fall has occurred.

**ALWAYS** read and understand the manufacturer's warnings and instructions on how to use and properly adjust the harness. Attach your Full Body Harness in the manner and method described by the manufacturer. Beware of hazards associated with Full Body Harnesses and the fact that prolonged suspension in a harness may be fatal. Have in place a plan for rescue, including the use of cell phones, or signal devices that may be easily reached while suspended. If rescue personnel cannot be notified, you must have a plan for recover/escape. If you have to hang suspended for a period of time before help arrives, exercise your legs by pushing against the tree or doing any other form of continuous motion. Failure to recover in a timely manner could result in serious injury or death. If you do not have the ability to recover/escape, hunt from the ground.

**DO NOT** use tree stand if any nuts or bolts or parts are loose, bent, or crooked.

**NEVER** let children play with or use this treestand without adult supervision. This treestand is not a toy.

**DO NOT** use this tree stand while under the influence of alcohol, medication or any illegal substances. Use of tree stand while under the influence of any of these substances may result in serious injury or death.

**NEVER** use this treestand during inclement weather. **DO NOT** use tree stand during thunderstorms, snowstorms, hurricanes, tornadoes or any other weather conditions that include (but not limited to) lightning, icy conditions, or high winds that could create slippery or dangerous situations. End your hunt and return to the ground if inclement weather conditions arise.

**NEVER** use this tree stand if you have a history of health problems such as (but not limited to) heart problems, back problems, high blood pressure, impaired vision, equilibrium impairments, are afraid of heights, have been advised by a doctor or physician not to climb. If you are not physically fit, well rested, and alert, or if you have any other physical or mental condition that would impair your ability to properly use this treestand.

**NEVER** use treestand If you are feeling ill, nauseous, dizzy or if you have a prior condition that could cause a problem. i.e., heart condition, joints that lock-up spinal fusions, etc. or if you are not well rested and alert. Physical ailments can reduce your ability to safely install, utilize, and remove your treestand. Please consult a physician prior to use.

**NEVER** wear jewelry or loose fitting clothing, which can cause hazardous conditions. Clothing may be caught in your equipment and cause you to fall. You must always wear non-slip or rubber boots. Shoelaces must be tucked into your boots. Rings and necklaces **MUST NOT** be worn.

**NEVER** use this tree stand on a tree that is dead, leaning, diseased, loose barked or on a utility pole as the tree may fall, break, or uproot and may result in serious injury or death.

**NEVER** transport any of your equipment with yourself while ascending or descending the tree. You will need to have two hands free during ascending and descending for safety. Use a haul line to pull up your firearm (unloaded, chamber opened with safety lock engaged, barrel facing towards the ground), bows, arrows, knives or any other equipment to your tree stand once you have reached your desired hunting height. **ONLY** pull up hunting equipment after the tree stand has been secured to the tree and after you and your harness have been secured to the tree. Prior to descending, lower your equipment on the opposite side of the tree from which you are climbing. Make sure that the unloaded firearm's safety lock is engaged and the gun barrel is pointing towards the ground.

**ALWAYS** hunt with a plan and a buddy. Before you leave home, let others know your exact location, when you plan to return and who is with you.

**ALWAYS** inform someone of the hunting location, where the treestand is located and the expected duration of the hunt.

## TREESTAND SAFETY WARNINGS

**ALWAYS** carry emergency signal devices such as a cell phone, walkie-talkie, whistle, signal flare, PLD (personal location device) and flashlight with you at all times and within reach even while you are suspended in your harness. Watch for changing weather conditions. In the event of an accident, remain calm and seek help immediately.

**NEVER** modify your tree stand in anyway by making repairs, replacing parts, or altering, adding or attaching anything to it except if explicitly authorized in writing by the manufacturer. Improper installation or adjustment may cause serious injury or death. Remove all contents from box. Inspect for any damaged or missing parts. If any parts are missing or damaged, you must only use certified replacement parts. Using any other replacement parts will void product warranty. **THERE ARE NO EXTRA PARTS.** All parts **MUST** be used to ensure the safety of you and your stand. If you think parts are missing or damaged, **STOP IMMEDIATELY** and contact our Customer Service Department. Using the tree stand with missing or damaged parts may result in serious injury or death. Contact a Customer Service Representative if you have any missing, damaged or extra parts.

**PRACTICE** installing, adjusting and using your tree stand at ground level prior to using it at an elevated position.

**ALWAYS** check the ground under the ladder stand to make sure the ground is firm and level. Sloping ground or uneven surfaces (one side of a rock or root) can cause your ladder stand to tilt or shift off the tree.

**ALWAYS** step firmly on the first rung of the bottom ladder section to set the ladder into the ground before proceeding to climb the ladder.

**ALWAYS** have a minimum of three people present when installing or removing this treestand.

**NEVER** use this treestand with a second person. The treestand is designed for use by **ONE** person.

**ALWAYS** know your physical limitations. Don't take chances. If you start thinking about how high you are, don't go any higher. Instead, choose a minimum height that will allow for safe, effective and comfortable hunting.

**NEVER** use this treestand for any use other than hunting. Our treestands are designed for hunter's to wear a Full Body Harness. If you are not completely comfortable and confident with your ability to safely install, ascend, hunt and descend using a Full Body Safety Harness and this treestand, **DO NOT PROCEED.**

**ALWAYS** lean **forward towards the tree** as you climb. **NEVER** lean out from the treestand for any reason.

**NEVER** use this treestand for trimming trees.

**NEVER** rely on a branch for support.

**NEVER** jump or bounce on the treestand's platform or ladder sections to seat it to the tree.

**NEVER** fall asleep in your stand as you may fall out resulting in serious injury or death.

**NEVER** adjust your stand while in use. **ALWAYS** ensure that you and your treestand are safely secured to a healthy tree. Your tree stand **MUST** be attached tightly to the tree and secured in place. If the stand is not secure, it may shift while in use, resulting in serious injury or death.

**MAINTAIN** three points of contact when climbing the tree stand. (Two feet, one hand or two hands, one foot).

Instructions should be kept in a safe place and reviewed before each use. It is the responsibility of the treestand owner to furnish the complete instructions to anyone who borrows or purchases the treestand from you.

**ALWAYS** be sure to retighten all bolts **BEFORE** each new use of treestand.

**DO NOT** leave your treestand outside. It must be stored inside when not in use.

**DO NOT** carry the stand when ascending or descending the tree. Use a haul line to raise and lower your stand.

Climbing aids such as stick ladders, sectional ladders, steps or such **MUST** extend above the platform of the hang-on to allow the user to step down on the platform. **NEVER** step up to the platform. When using a climbing belt to ascend the tree, the Full Body Harness should be attached to the tree before stepping down into the treestand.

**NEVER** leave the ground without checking every ladder section connection. If ladder sections are separating, with the help of three other people, remove the ladder stand from the tree, tighten all connections and reinstall onto the tree.

**NEVER** remove any safety warning stickers from this product. Safety must be your first priority during the use of this product.

# ! WARNING

**DO NOT** use this stick ladder without reading and following all warnings and instructions before each use. Failure to do so may result in serious injury or death.

**ALWAYS** inspect your stick ladder before each use and **DO NOT** use if parts are missing, worn, or damaged.

**ALWAYS** wear a Full Body Harness with climbing belt when using stick ladder. Failure to wear Full Body Harness with climbing belt may result in serious injury or death.

**DO NOT** exceed the stick ladder's weight limit, which includes your body weight as well as the weight of your clothes and gear. Exceeding the stick ladder's weight limit may cause the stick ladder to break or fail resulting in serious injury or death.

**NEVER** make any alterations or modifications to the stick ladder. Doing so may result in serious injury or death. void all warranties.

**NEVER** use stick ladder on a tree that is dead, diseased, leaning, or when the ground is uneven as the tree may break or fall, resulting in serious injury or death.

**NEVER** use stick ladder during inclement weather. **DO NOT** use stick ladder during thunderstorms or any other weather conditions (but not limited to) lightning, freezing rain, high wind, that could create slippery or dangerous conditions.

**DO NOT** use this stick ladder under the influence of alcohol, drugs, or medication. Using stick ladder under the influence of alcohol or medication may result in serious injury or death.

**NEVER** use stick ladder if you have dizzy spells, a heart problem, are afraid of heights, have been advised by a doctor or other health care provider not to climb, or have any condition that would impair your ability to climb up or down or use stick ladder as it could result in serious injury or death.

**NEVER** remove or deface stick ladder warning labels. Replacement labels can be obtained from the address below.

# MODEL: 51002 20Ft. Stick Ladder

- Always Wear a Safety Harness with this Product
- Practice Using at Ground Level
- Weight Limit: 300 lbs.
- Tree Size: 9"-18" diameter

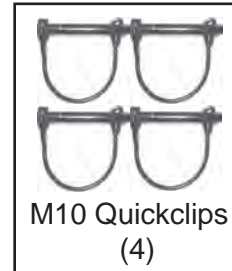
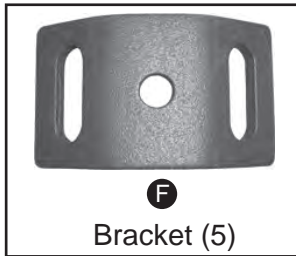
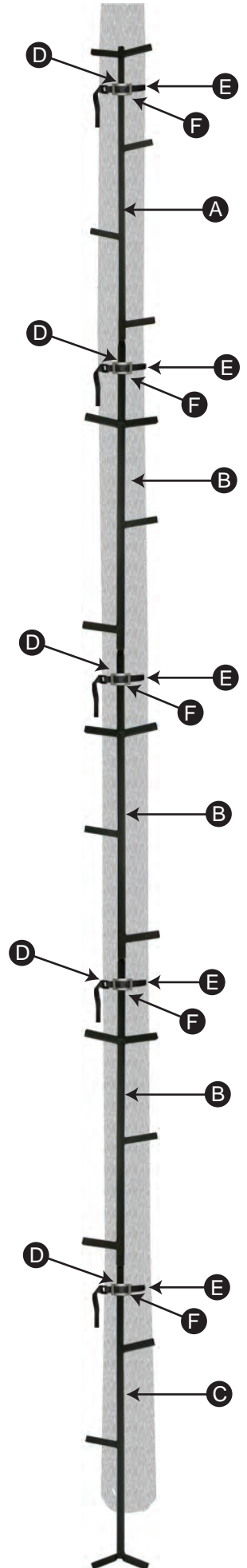
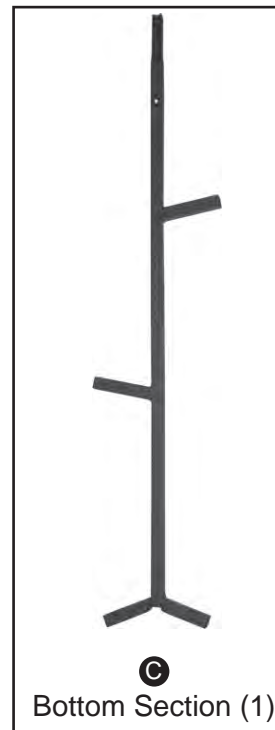

Parts List		
<b>A</b>	1 Top Section	Part # WL-1000
<b>B</b>	3 Middle Section	Part # WL-1250
<b>C</b>	1 Bottom Section	Part # WL-1500
<b>D</b>	5 Tree Brace	Part # WTB-100
<b>E</b>	5 Buckle Strap	Part # WCB-100
<b>F</b>	5 Bracket	Part # WB-100
<b>65</b>	5 M12x65mm Bolt w/wingnut	Part # 1265W
	4 M10 Quickclips	Part # 1615



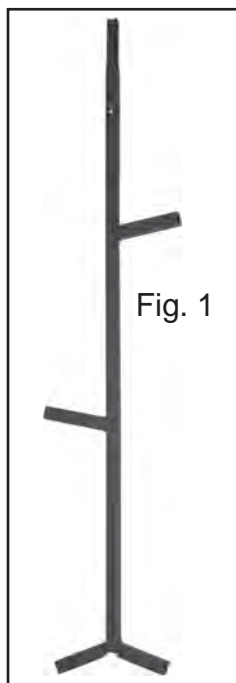

Fig. 1

1. Lay Bottom Section **C** on the ground with the first step on the left hand side. (Fig. 1).

2. The first step of Middle Section **B** should be facing the left hand side. Insert the male end of Bottom Section **C** into the female end of Middle Section **B**. (Fig. 2) Insert one quickclip through each section at the insertion point. (Fig. 3)

The steps will need to be in an alternating left, right, left, right pattern. Make sure that the **Bottom, Lower Middle, and the Upper Middle Sections** have the first step on the **LEFT** hand side.

The **Middle Middle Section and the Top Ladder Section** will have the first step on the **RIGHT** hand side.

3. Insert the rest of the sections together by following the above steps. Make sure all connections are tightened securely. Insert one quickclip into each section at each insertion point. (Fig.3)

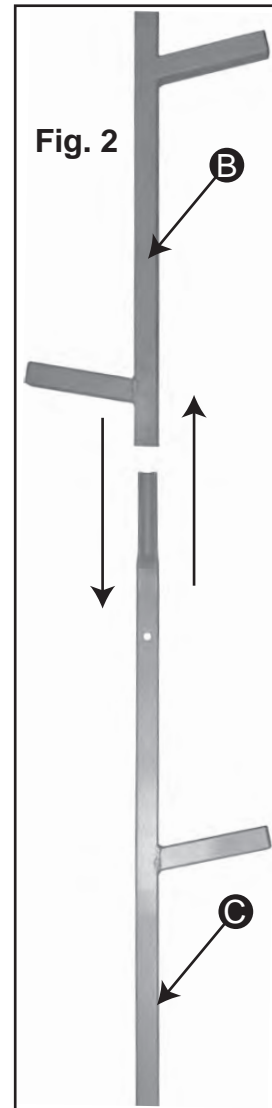
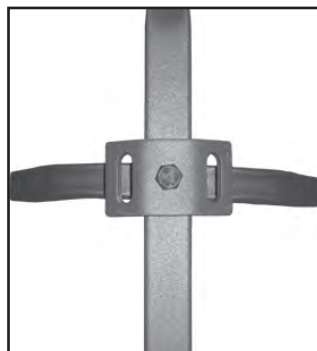
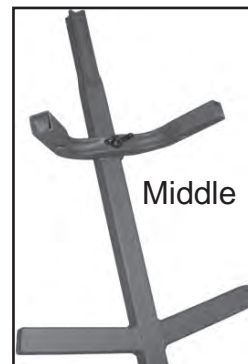

Fig. 2

Fig. 3



Top



Middle



Bottom

4. Attach Bracket **F** to the front of each stick ladder section and Tree Brace **D** to the back of each stick ladder section using **1 - M12x65mm Bolt** for each section. Wingnut must be installed between the tree brace and the tree. Tighten securely.



1. Thread the buckle strap through one end of the bracket, over the top of the bracket, then through the other side of the bracket. Pull the strap all the way through so the buckle end is against the bracket. The straps will be attached to the bracket and hang freely until the Stick Ladder is ready to be secured to the tree.

2. Make sure that the steps of the stick ladder all angle upward. With the help of at least two other people, walk the assembled stick ladder up to the desired tree so that all of the tree braces are firmly against the tree. The stick ladder **MUST** be straight and vertical. **DO NOT** use on a leaning or dead tree. The tree should also have a diameter between 9 and 18 inches.

3. While holding the stick ladder against the tree, press your weight on the first step so that the base of the bottom section settles firmly and completely into the ground.

4. Wrap the Buckle Strap from the bottom section around the back of the tree and insert the strap through the buckle. (See Fig. 6) Make sure that the strap is flat against tree with no slack. Secure section to the tree before climbing.

5. Attach Full Body Safety Harness with Climbing Belt to yourself and the tree according to the manufacturer's instructions.

6. Climb the bottom section of the stick ladder to reach the Second Section. Stand on the Bottom Section to secure the second strap to the Middle Section. Make sure section is secure before climbing any further.

7. Continue with step 6 for third and fourth sections.

8. When installing and removing stick ladder sections do not undo any strap until you are standing securely on the section below.

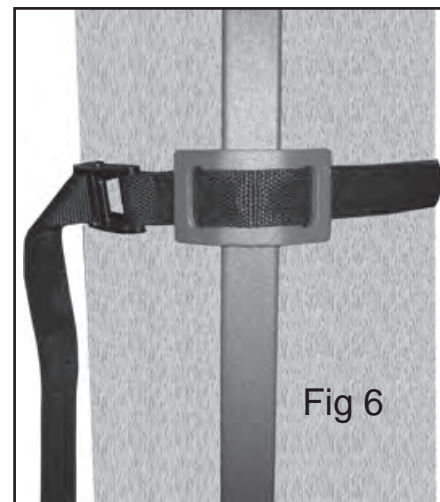
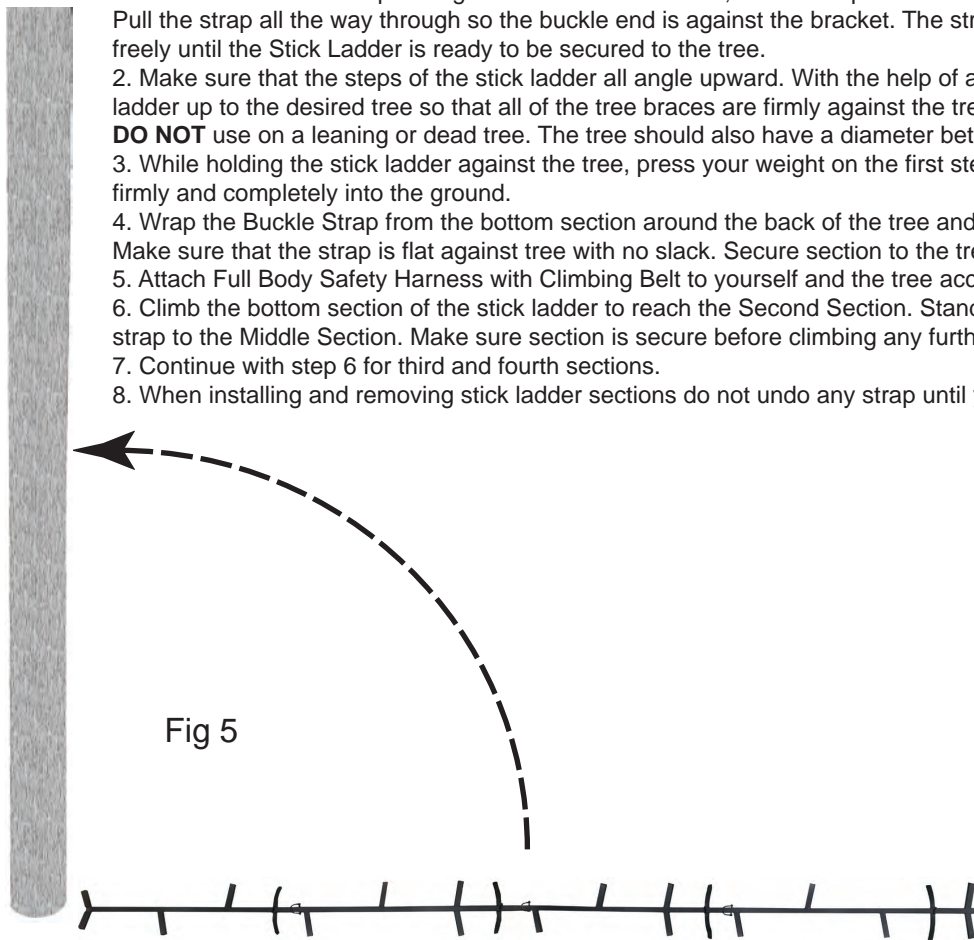

## Detailed Buckle and Strap Instructions

