

**MODEL: HEH00517**  
**Ladder Extension**  
**with Theft Deterrent Feature**  
**and Levelers**

- Always Wear a Safety Harness with this Product
- Practice Using at Ground Level
- Tree Size: 9"-18" diameter

**FIELD & STREAM™**

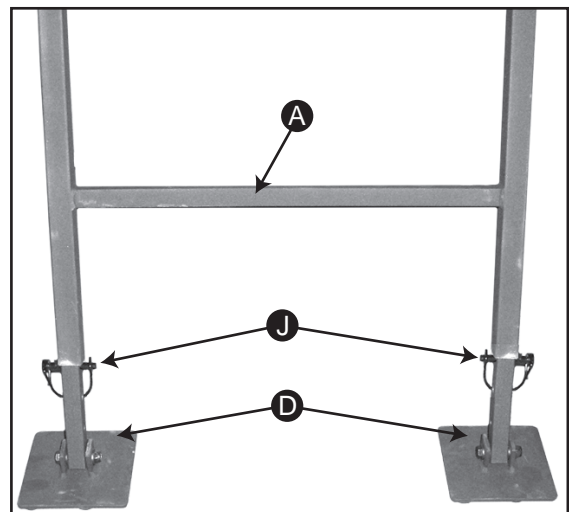
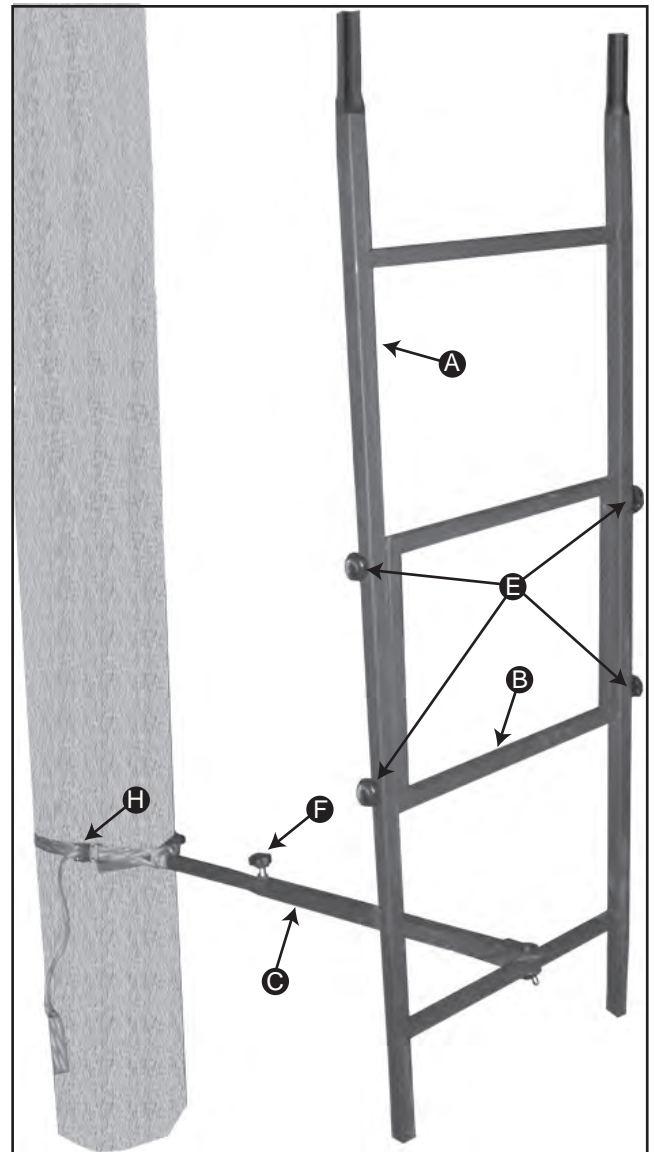

**⚠ Warning ⚠ Warning ⚠ Warning ⚠**

The enclosed ladder section is only to be used to extend the ladder section for Ladder Stand Model #'s HEH00501, HEH00502, HEH00503, HEH00504, HEH00506, and HEH00507.

**USE ONLY ONE SECTION PER TREESTAND**

Using additional ladder sections over the designated height other than the heights specified in the user instructions **CAN CAUSE SERIOUS INJURY OR DEATH**

Follow all instructions and warnings before each use detailed in your original assembly instructions.

**THANK YOU!** for purchasing this Ladder Extension by Primal Vantage Company Inc.

**⚠ Warning**

**Every year serious injury and even death occurs from hunting related falls.** To ensure your safety, please **COMPLETELY** read and follow this safety manual and ALL warning labels **BEFORE** assembling, installing or utilizing this product.

DO NOT USE THIS PRODUCT BEFORE FULLY UNDERSTANDING ALL SAFETY WARNINGS AND INSTRUCTIONS. IF YOU HAVE QUESTIONS, ARE UNSURE ABOUT ANY INFORMATION OR NEED ADDITIONAL INFORMATION CONCERNING YOUR PRODUCT, CONTACT OUR CUSTOMER SERVICE DEPARTMENT AT 1-800-722-7345 OR VISIT [WWW.TREESTANDCUSTOMERSERVICE.COM](http://WWW.TREESTANDCUSTOMERSERVICE.COM). KEEP AND MAINTAIN THIS SAFETY AND INSTRUCTION MANUAL IN A SAFE LOCATION FOR FUTURE REFERENCE.

## TREESTAND SAFETY WARNINGS

Please read the following instruction manual and warnings labels completely before utilizing this tree stand. Failure to understand and execute the instructions and warnings may result in serious injury or death. In the event of an accident, have a plan for rescue, including the use of devices that may be easily reached while suspended. **NEVER** hunt without a rescue plan.

**ALWAYS** read all warnings and instructions before each use of this tree stand. Failure to read all warnings and instructions may result in serious injury or death.

**ALWAYS** wear a Fall Arrest System (FAS) (Harness) after leaving the ground. Failure to wear your Fall Arrest System (Harness) may result in serious injury or death.

**ALWAYS** use a Full Body Safety Harness when using this tree stand. This tree stand includes a TMA Certified Full Body Harness. The TMA Certified Full Body Harness must always be connected to yourself and the tree during ascending, hunting and descending. Falls can occur at anytime after leaving the ground.

**ALWAYS** inspect the tree stand and the **Fall Arrest System** (Harness) for signs of wear or damage **BEFORE** each use. Also inspect to ensure that nuts and bolts are secure. Pay special attention to the harness and straps, guaranteeing that nothing has been frayed or severed. Destroy all products that cannot be repaired by the manufacturer. Contact a Customer Service Representative for replacement parts. The Fall Arrest System **MUST** be discarded and replaced after a fall has occurred.

**DO NOT** use tree stand if any nuts or bolts or parts are loose, bent, or crooked.

**NEVER** exceed weight limit of **300 lbs**. **DO NOT** use if your combined weight with all of your hunting gear and any accessories exceeds **300 lbs**. Use of tree stand over the weight limit may result in serious injury or death.

**NEVER** let children play with or use this tree stand without adult supervision. This tree stand is not a toy.

**DO NOT** use this tree stand while under the influence of alcohol, medication or any illegal substances. Use of tree stand while under the influence of any of these substances may result in serious injury or death.

**NEVER** use this tree stand during inclement weather. **DO NOT** use tree stand during thunderstorms, snowstorms, hurricanes, tornadoes or any other weather conditions that include (but not limited to) lightning, icy conditions, or high winds that could create slippery or dangerous situations.

**NEVER** use this tree stand if you have a history of health problems such as (but not limited to) heart problems, back problems, high blood pressure, impaired vision, equilibrium impairments, are afraid of heights, have been advised by a doctor or physician not to climb. If you are not physically fit, well rested, and alert, or if you have any other physical or mental condition that would impair your ability to properly use this tree stand.

**NEVER** use tree stand if you are feeling ill, nauseous, or dizzy. Physical ailments can reduce your ability to safely install, utilize, and remove your tree stand. Please consult a physician prior to use.

**NEVER** wear jewelry or loose fitting clothing, which can cause hazardous conditions. Clothing may be caught in your equipment and cause you to fall. You must always wear non-slip or rubber boots. Shoelaces must be tucked into your boots. Rings and necklaces **MUST NOT** be worn.

**NEVER** use this tree stand on a tree that is dead, leaning, diseased, loose barked or on a utility pole as the tree may fall, break, or uproot and may result in serious injury or death.

**NEVER** transport any of your equipment with yourself while ascending or descending the tree. You will need to have two hands free during ascending and descending for safety. Use a haul line to pull up your firearm (unloaded, chamber opened with safety lock engaged, barrel facing towards the ground), bows, arrows, knives or any other equipment to your tree stand once you have reached your desired hunting height. **ONLY** pull up hunting equipment after the tree stand has been secured to the tree and after you and your harness have been secured to the tree. Prior to descending, lower your equipment on the opposite side of the tree from which you are climbing. Make sure that the unloaded firearm's safety lock is engaged and the gun barrel is pointing towards the ground.

**ALWAYS** hunt with a plan and a buddy. Before you leave home, let others know your exact location, when you plan to return and who is with you.

**ALWAYS** attach your Full Body Harness in the manner and method described by the manufacturer. Beware of hazards associated with Full Body Harnesses and the fact that prolonged suspension in a harness may be fatal. Have in place a plan for rescue, including the use of cell phones, or signal devices that may be easily reached while suspended. If rescue personnel cannot be notified, you must have a plan for recover/escape. If you have to hang suspended for a period of time before help arrives, exercise your legs by pushing against the tree or doing any other form of continuous motion. Failure to recover in a timely manner could result in serious injury or death. If you do not have the ability to recover/escape, hunt from the ground.

**ALWAYS** carry emergency signal devices such as a cell phone, walkie-talkie, whistle, signal flare, PLD (personal location device) and flashlight with you at all times and within reach even while you are suspended in your harness. Watch for changing weather conditions. In the event of an accident, remain calm and seek help immediately.

**DO NOT** modify or alter your tree stand. Improper installation or adjustment may cause serious injury or death. Remove all contents from box. Inspect for any damaged or missing parts. If any parts are missing or damaged, you must only use certified replacement parts. Using any other replacement parts will void product warranty. **THERE ARE NO EXTRA PARTS**. All parts **MUST** be used to ensure the safety of you and your stand. If you think parts are missing or damaged, **STOP IMMEDIATELY** and contact our Customer Service Department. Using the tree stand with missing or damaged parts may result in serious injury or death. Contact a Customer Service Representative if you have any missing, damaged or extra parts.

**PRACTICE** installing, adjusting and using your tree stand at ground level prior to using it at an elevated position.

**ALWAYS** step firmly on the first rung of the bottom ladder section to set the ladder into the ground before proceeding to climb the ladder.

**NEVER** use homemade or permanently elevated stands or make modifications to a purchased tree stand.

## TREESTAND SAFETY WARNINGS

**ALWAYS** have a minimum of three people present when installing or removing this tree stand.

**ALWAYS** know your physical limitations. Don't take chances. If you start thinking about how high you are, don't go any higher. Instead, choose a minimum height that will allow for safe, effective and comfortable hunting.

**NEVER** use this tree stand for any use other than hunting. Our tree stands are designed for hunters to wear a Full Body Harness. If you are not completely comfortable and confident with your ability to safely install, ascend, hunt and descend using this treestand and a Full Body Safety Harness, **DO NOT PROCEED**.

**ALWAYS** lean **forward towards the tree** as you climb and attach your harness to the tree before securing the platform to the tree and stepping onto the platform.

**NEVER** lean out from the tree stand for any reason.

**NEVER** use this treestand for trimming trees.

**NEVER** rely on a branch for support.

**NEVER** jump or bounce on the tree stand's platforms or ladder sections to seat it to the tree.

**NEVER** fall asleep in your tree stand as you may fall out resulting in serious injury or death.

**NEVER** adjust your tree stand while in use. **ALWAYS** ensure that you and your tree stand are safely secured to a healthy tree. Your tree stand **MUST** be attached tightly to the tree and secured in place. If the stand is not secure, it may shift while in use, resulting in serious injury or death.

**ALWAYS** maintain three points of contact when climbing the tree stand. (Two feet, one hand **or** one foot, two hands)

Instructions should be kept in a safe place and reviewed before each use. Furnish instructions to anyone who borrows or purchases the tree stand from you.

**ALWAYS** be sure to retighten all bolts **BEFORE** each new use of tree stand.

**DO NOT** leave your tree stand outside. It must be stored inside when not in use.

The Installation Cross Straps and Stabilizer Bar **MUST** be properly installed before each use of treestand.

**ALWAYS** inspect every ladder section connection every time you use the tree stand before leaving the ground. If the ladder sections are separating, with the help of three other people remove the tree stand from the tree and reinstall.

**ALWAYS** check the ground under the tree stand to make sure it is firm and level. Sloping ground or uneven surfaces (one side of a rock or root) can cause your tree stand to tilt or shift off the tree.

**ALWAYS** read and understand all warnings and instructions before each use of tree stand. Failure to read and understand all warnings and instructions may result in serious injury or death.

**NEVER** use this tree stand with a second person. The product is designed for use by **ONE** person **ONLY**.

Read and understand manufacturer's warnings, expiration date (if applicable) and instructions on how to properly adjust the harness.

**PRACTICE** using the Full Body Safety Harness at ground level in the presence of a responsible adult to experience the feeling of hanging suspended before using in a hunting environment.

There is time to make a correct decision on what action to take if a fall occurs while wearing a Full Body Harness. It is important to remember do not panic.

**NEVER remove any safety warning stickers from this product.  
Safety must be your first priority during the use of this product.**

# WARNING

**ALWAYS** read and understand all warnings and instructions before each use of this product. Failure to read and understand all warnings and instructions may result in serious injury or death.

**ALWAYS** inspect the tree stand for signs of wear or damage **BEFORE** each use. Also inspect to ensure that nuts and bolts are secure and straps are not frayed, worn, or broken.

**NEVER** exceed weight limit of **300 lbs.** **DO NOT** use if your combined weight with all your hunting gear and accessories exceeds **300 lbs.** Use of tree stand above the weight limit may result in serious injury or death.

**ALWAYS** wear your Full Body Safety Harness (FBS) on level ground. If you are not wearing an FBS, do not use the tree stand on **ground**. Failure to wear an FBS may result in serious injury or death.

**DO NOT** use this tree stand while under the influence of alcohol, medication, or other substances. Use of tree stand while under the influence of any of these substances may result in serious injury or death.

Manufactured in the year XXXX

**NEVER** use this tree stand if you have a history of health problems such as (but not limited to) heart problems, back problems, impaired vision, equilibrium impairments are afraid of heights or have been advised by a doctor not to do any strenuous activity. If you are feeling ill, nauseous, or dizzy **DO NOT** use the tree stand or if you are not physically fit, well rested, or free of medical ailments can reduce your ability to safely use, utilize, or remove your tree stand.

**NEVER** use this tree stand in inclement weather such as (but not limited to) rain, snow, sleet, storms, high winds, ice, or other conditions that may create slippery or dangerous situations.

**NEVER** use this tree stand on dead, leaning, loose barked tree or on a utility pole as they may fall, break, or uproot and may result in serious injury or death.

**NEVER** leave the ground without checking every ladder section connection to ensure they are firmly connected. If ladder sections are separating, with the help of at least two other people, remove the tree stand from the tree, tighten all connections and reinstall on the tree.

**NEVER** step up to the tree stand using climbing aids such as stick ladders, **MUST** stand above the platform of the tree stand to step down on the platform. The Full Body Safety Harness **MUST** always be attached to the tree and not the tree stand when stepping down into the tree stand.

**DO NOT** modify or alter the tree stand.

**NEVER** remove or deface warning labels.

SAMPLE

FIELD & STREAM™

Primal Vantage Company Inc. 685 Route 10 East, Randolph, NJ 07869 1-800-722-7345 Contact for replacement labels

**MODEL: HEH00517**  
**Ladder Extension**  
**with Theft Deterrent Feature**  
**and Levelers**

- Always Wear a Safety Harness with this Product
- Practice Using at Ground Level
- Tree Size: 9"-18" diameter

**Parts List**

<b>A</b>	1 Ladder Section	Part # DL-8600
<b>B</b>	1 Removable Rung	Part # DRR-860
<b>C</b>	1 Stabilizer Bar	Part # DSB-100
<b>D</b>	2 Ladder Leveler	Part # DLL-860
<b>E</b>	4 Installation Knob	Part # IK-100
<b>F</b>	1 Adjustment Knob	Part # AK-100
<b>G</b>	2 Sleeve	Part # DS-100
<b>H</b>	1 Buckle Strap Assy	Part # DBA-200
<b>J</b>	4 M10 Quickclip	Part # 1015
<b>45</b>	1 M12x45mm Bolt w/wingnut	Part # 1245W

**FIELD & STREAM™**

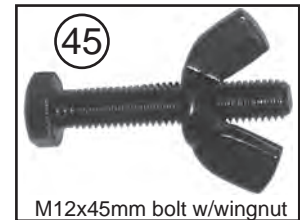
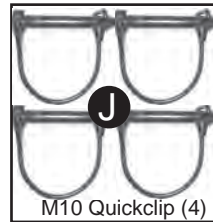
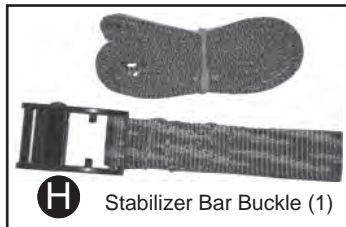
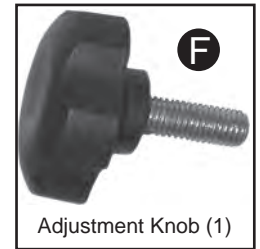
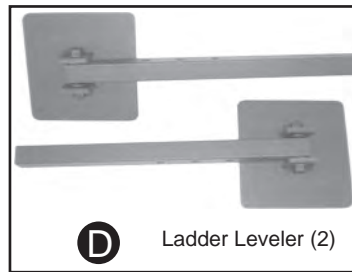
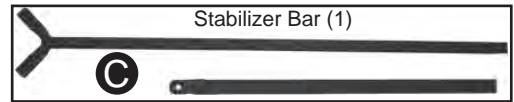
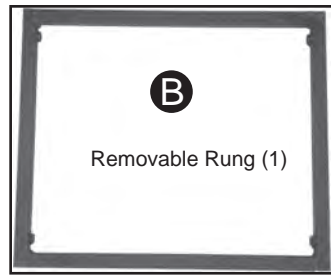
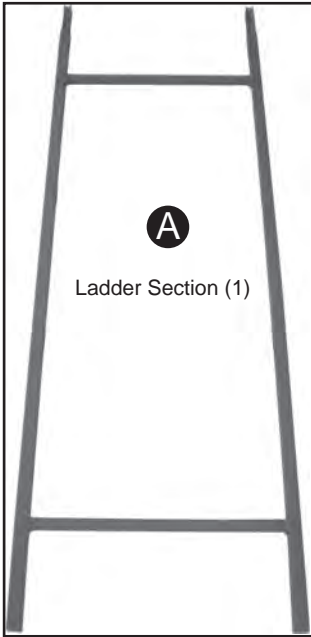

**⚠ WARNING ⚠**  
 Ladder Levelers for use  
 on Bottom Ladder Section  
 ONLY

**⚠ Warning ⚠ Warning ⚠ Warning ⚠**

The enclosed ladder section is only to be used to extend the ladder section for Ladder Stand Model #'s HEH00501, HEH00502, HEH00503, HEH00504, HEH00506, and HEH00507.

**USE ONLY ONE SECTION PER TREESTAND**

Using additional ladder sections over the designated height other than the heights specified in the user instructions **CAN CAUSE SERIOUS INJURY OR DEATH**

Follow all instructions and warnings before each use detailed in your original assembly instructions.

**You MUST** lower the stand to the ground before assembling the Ladder Section to your stand.  
**You MUST** have the help of at least two other people

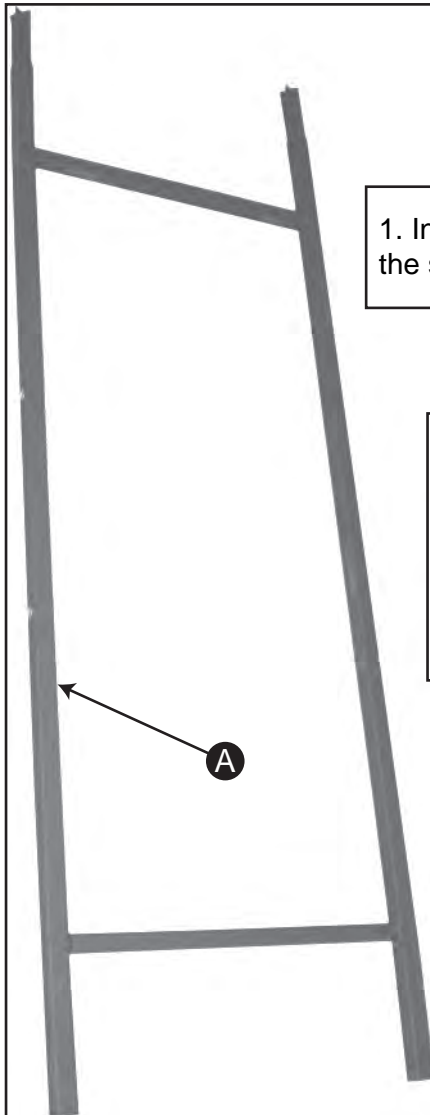

1. Insert Removable Rung **B** into the space on Ladder Section **A**.

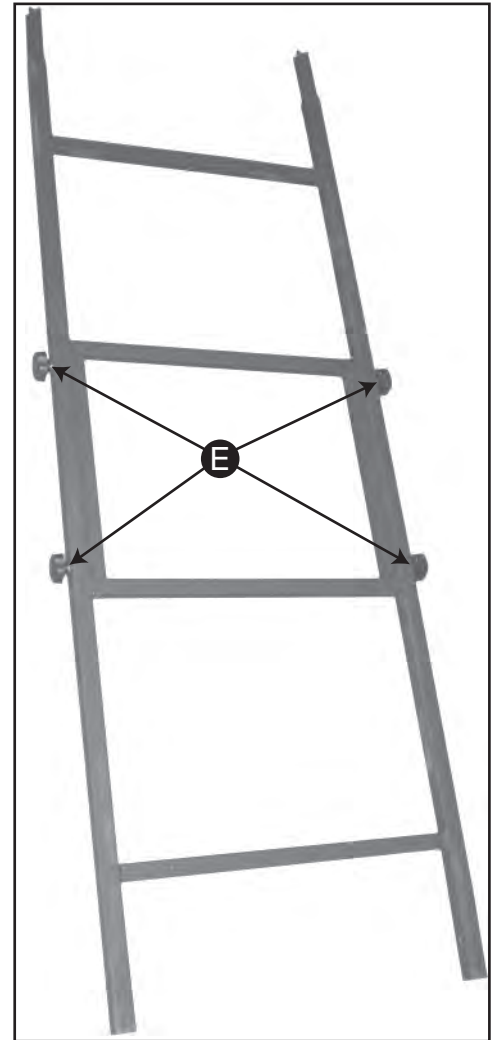
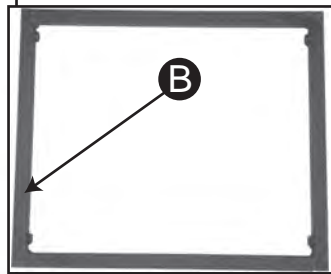

2. Thread each Installation Knob **E** through the ladder section and into the threaded holes of the Removable Rung **B**.

## ⚠ WARNING ⚠

DO NOT use Ladder Section without the Removable Rung installed. Using the Ladder Section without the Removable Rung installed may result in serious injury or death.

**You MUST** lower the stand to the ground before assembling the Ladder Section to your stand.  
**You MUST** have the help of at least two other people

3. With the help of at least two other people, lower your stand to the ground. Disassemble the ladder sections from each other.

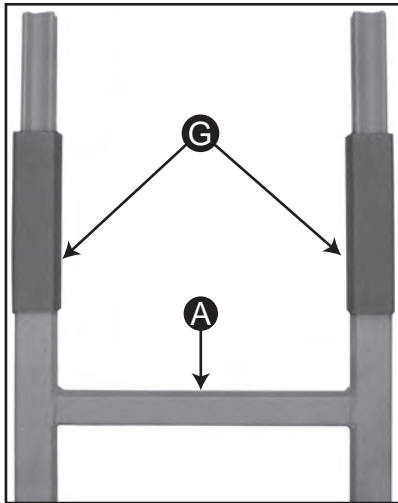

4. Slide Sleeves **G** over the crimps of Ladder Section **A**.

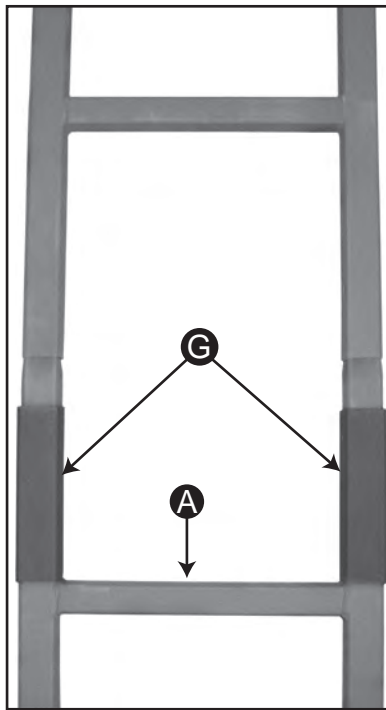

5. Insert Ladder Section **A** into the Original Middle Ladder Section.



6. Slide the Sleeves over the joint where ladder sections are connected.

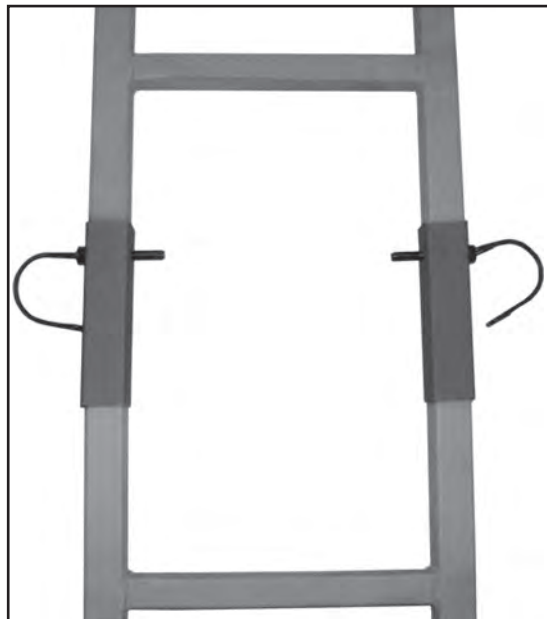

7. Insert 1 - **Quickclip** through the hole on the sleeve, and through the ladder sections on each side of the ladder.

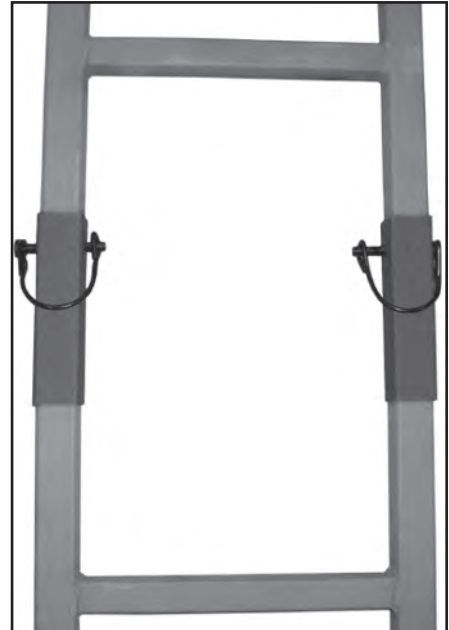

8. Close the quickclip to secure the ladder sections together.

## Ladder Extension with Theft Deterrent and Levels

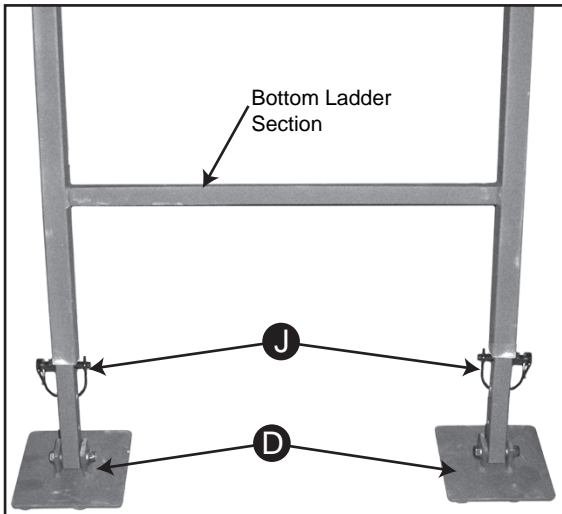

**⚠ WARNING ⚠**  
Ladder Levels for use  
on Bottom Ladder Section  
**ONLY**

9. Insert each Ladder Level **D** into the Bottom Ladder Section of your Ladderstand. Insert **1-M10 Quickclip J** through the predrilled holes in the ladder level. The ladder section will rest **ON TOP** of the quickclips.

10. Slide Original Bottom Ladder Section into the Theft Deterrent Ladder Extension. Secure the sleeves between the joints. Slide the Extension into the Original 2nd Ladder Section. Secure the sleeves between the joints. Follow steps 4 through 8 on the previous page to reinstall the 2nd Ladder Section into the Top Ladder Section.

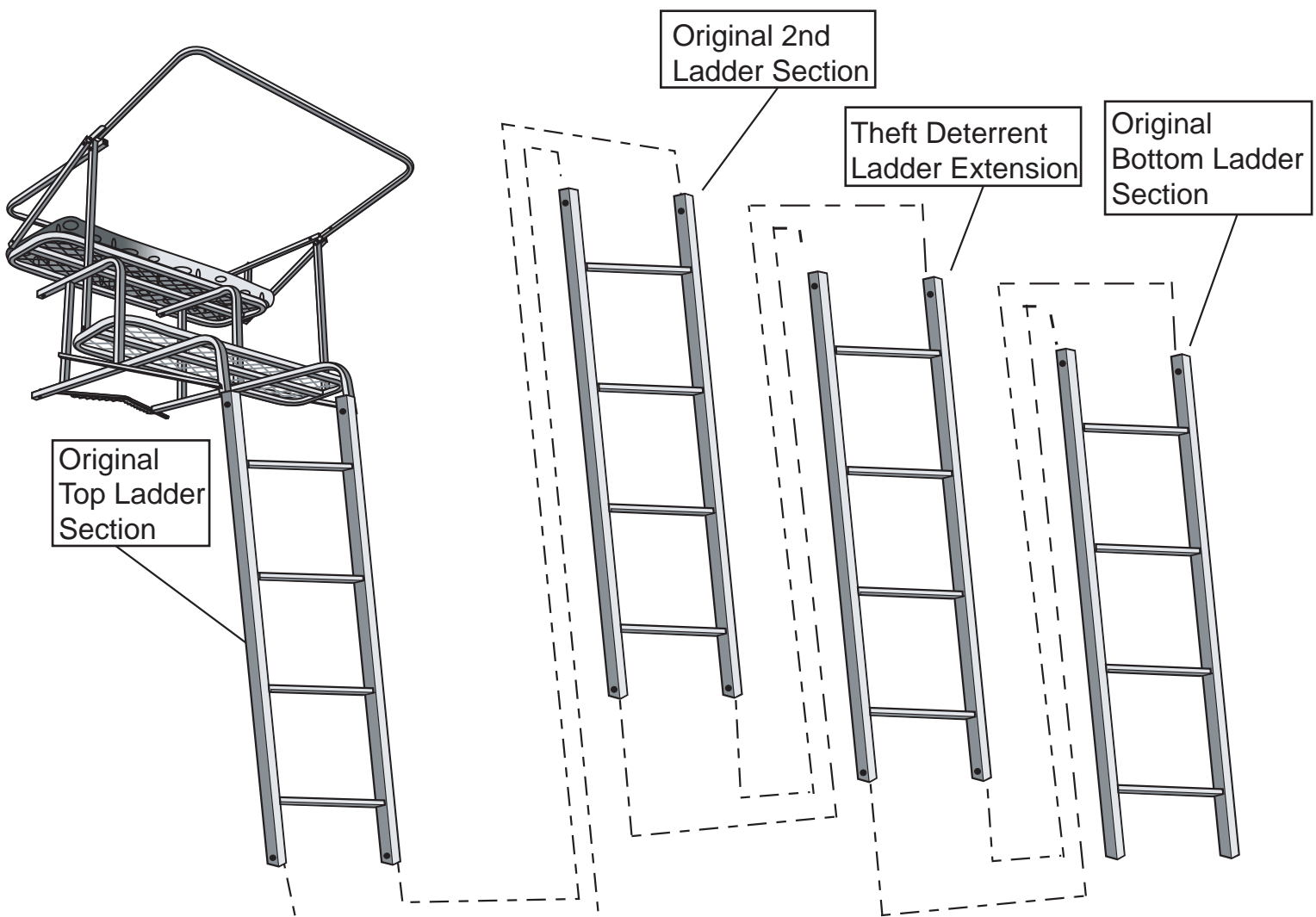

Style of ladderstand may vary. Please refer to manufacturer's original instructions for assembly.

# Installation Instructions Page 1

MODEL: HEH00517  
**Ladder Extension  
with Theft Deterrent  
and Levelers**

1. Make sure Installation Straps and Ratchet straps are still secured on each side of the platform by following **Original Manufacturer's Instructions**.

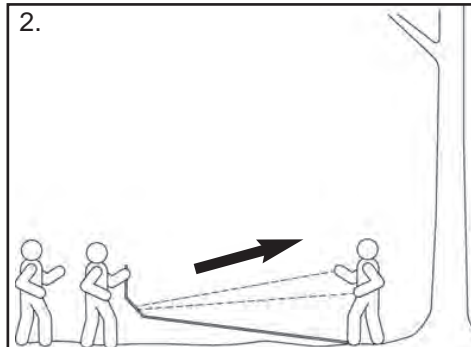

2. With the help of at least two other people. Position bottom of stand 4-5 feet from base of tree.

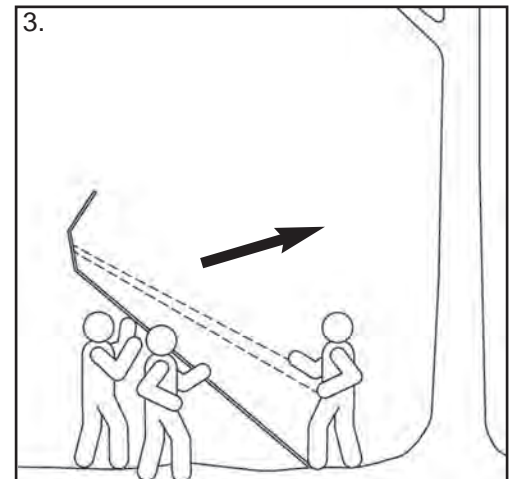

3. One person will stand at the base of ladder with his/her foot on bottom rung while holding installation straps. This will prevent tree stand from sliding. Two people will stand at opposite ends of tree stand, facing Platform and slowly walk tree stand upward using rungs of ladder.

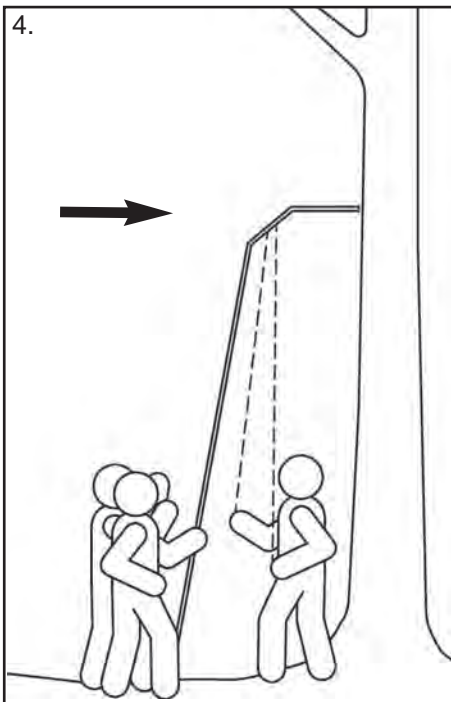

4. As tree stand is being raised, the person holding Installation Straps will pull toward themselves to take up slack. It will steady and ease the weight of stand on the other two people. Continue walking stand upward, until Tree Contact is resting against the tree.

5. Slide the inner part of the Stabilizer Bar into the outer part. Attach Stabilizer Bar **C** to the bottom rung of the Ladder Extension with **1 - 12x45W bolt and 1 wingnut**.

Insert the Adjustment Knob **F** in the Stabilizer bar at the proper adjustment point to the tree.

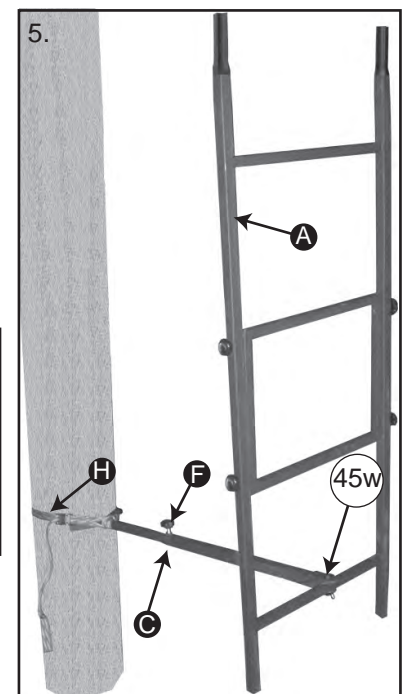

**NOTE:** Drawings are for illustration purposes only. Drawings may not depict actual product.

**WARNING** Installation Straps and Stabilizer Bars **MUST** be secured prior to climbing the tree stand.

MODEL: HEH00517

## Ladder Extension with Theft Deterrent and Levelers

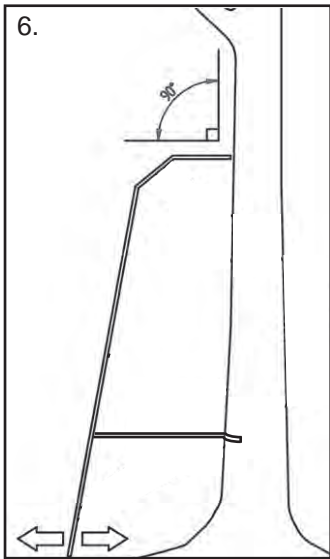

6. Move base of ladder toward or away from tree slightly in order to make Platform as parallel to the ground as possible.

Apply your full weight to the first step so it settles into the ground.

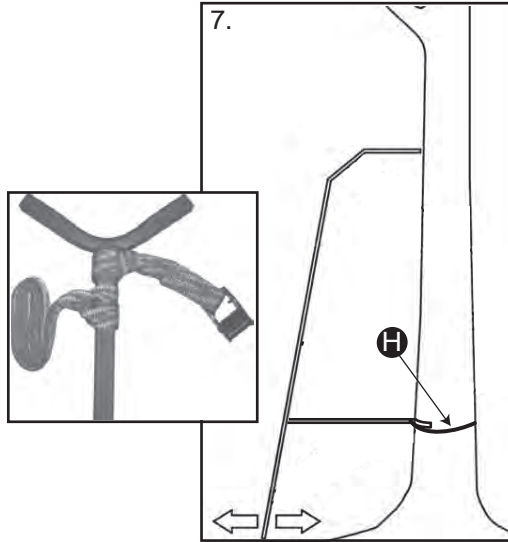

7. Attach Stabilizer Buckle Strap (H) just behind the brace of the inner part of Stabilizer Bar (C).

Position the Stabilizer Bar against the tree and secure it by wrapping the strap around the back of the tree once and insert the strap into the buckle. (See Buckle Instructions)

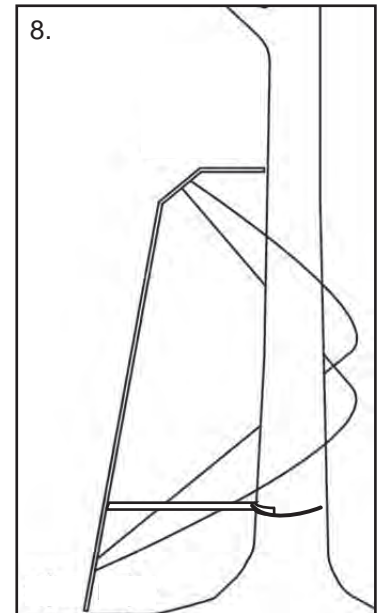

8. Cross Installation Straps behind tree. Attach to the bottom ladder section.

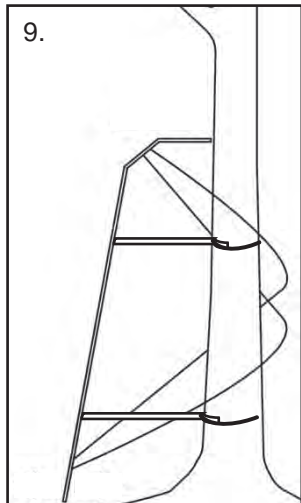

9. Attach original stabilizer to the top rung of the second ladder section using the hardware and straps from the original assembly.

**⚠ WARNING**  
Installation Straps and Stabilizer Bars **MUST** be secured prior to climbing the tree stand.

10. After the ladder stand has been secured to the tree with the installation straps, and the stabilizer bar has been securely attached to the tree, continue to have two people hold the ladder, climb cautiously up to the platform. Once you reach the top, **IMMEDIATELY ATTACH YOUR SAFETY HARNESS TO THE TREE.** Keep the tether strap above your head.



11. Cautiously climb to the top of the treestand. Wrap the strap of the ratchet around the back of the tree and thread it through the ratchet.

### Detailed Ratchet Strap Instructions

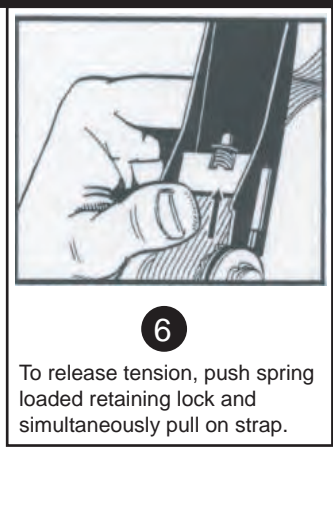
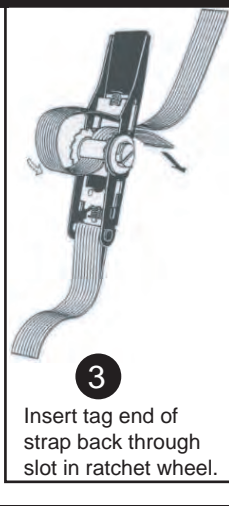
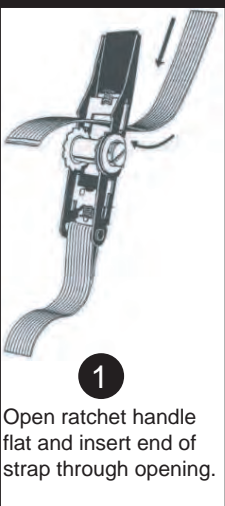

**⚠ WARNING** DO NOT sit on seat platform until the ratchet has been secured.

# DETAILED BUCKLE AND STRAP INSTRUCTIONS



Fig. 1

1. Hold buckle as shown in Fig. 1

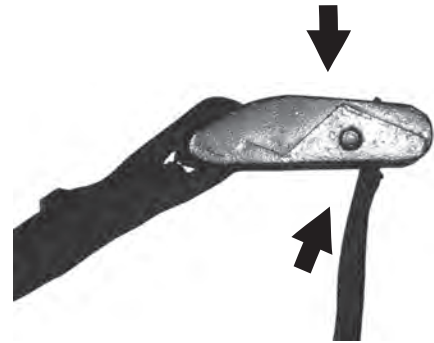

Fig. 2

2. Press down on latch and insert strap underneath teeth as shown in Fig. 2.



Fig. 3

3. Pull strap to desired length.

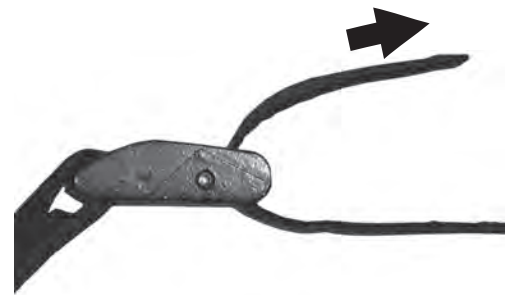

Fig. 4

4. Pull slack to tighten.  
(See Fig. 4)